

1 Wall Types 1 - 38 Series Cedar Texture Lap (Strand)



LP® SmartSide®

Lap Siding
38 Series Cedar Texture
Lap (Strand)

LPCorp.com
800-450-6106

Notes:
These drawings are general illustrations and are not to be used as final construction details. Check your local building codes before installing siding to confirm whether wood structural panel wall sheathing is required. Follow all manufacturer instructions and applicable building codes.

For additional information, go to lpcorp.com/resources/product-literature

For realistic texture previews, place the "LP Building Solutions Product Textures" folder in your C:\ directory and then reopen this file.

©2019 Louisiana-Pacific Corporation. All rights reserved.

Scale



LP® SmartSide®

Lap Siding
76 Series Cedar Texture
Lap (Strand)

LPCorp.com
800-450-6106

Notes:
These drawings are general illustrations and are not to be used as final construction details. Check your local building codes before installing siding to confirm whether wood structural panel wall sheathing is required. Follow all manufacturer instructions and applicable building codes.

For additional information, go to lpcorp.com/resources/product-literature

For realistic texture previews, place the "LP Building Solutions Product Textures" folder in your C:\ directory and then reopen this file.

©2019 Louisiana-Pacific Corporation.
All rights reserved.

Scale

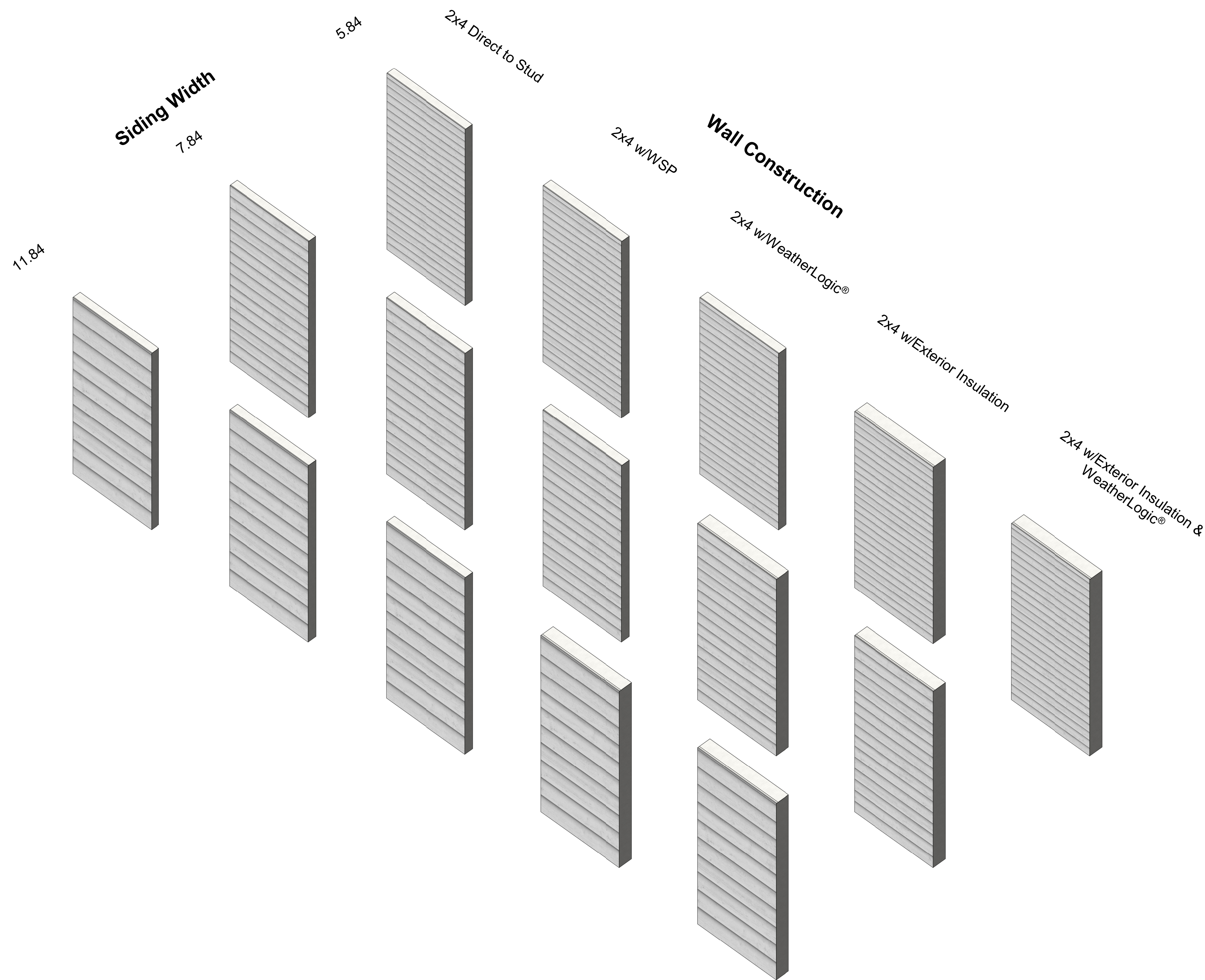

① Wall Types 2 - 76 Series Cedar Texture Lap (Strand)

11.84

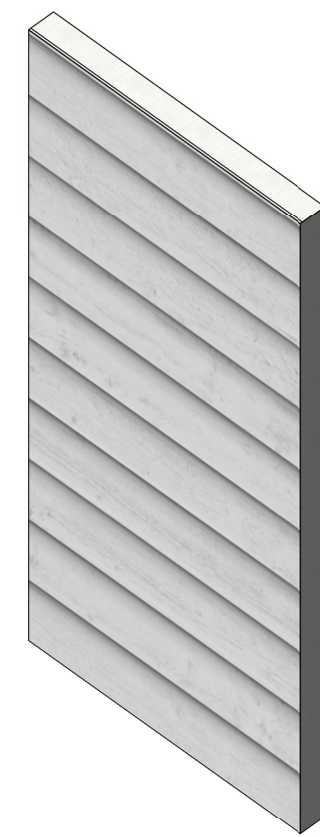

Siding Width

9.47

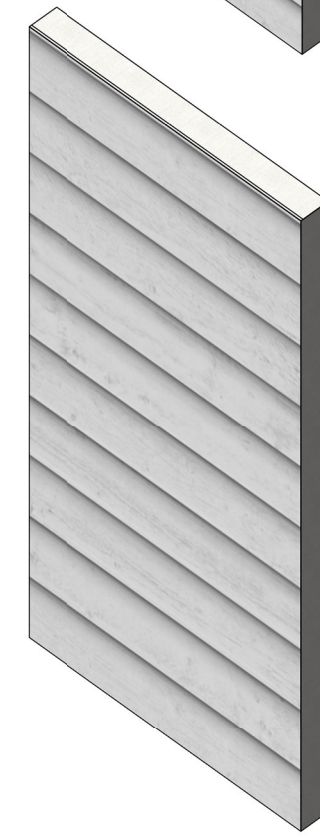
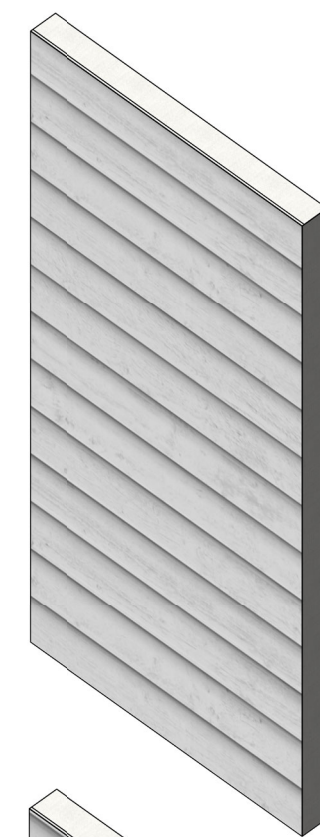

7.84

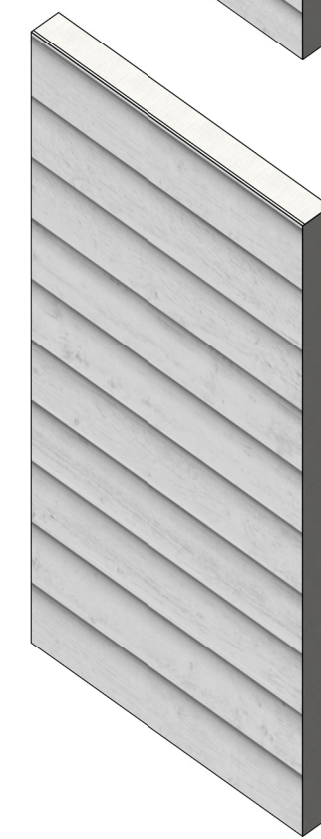
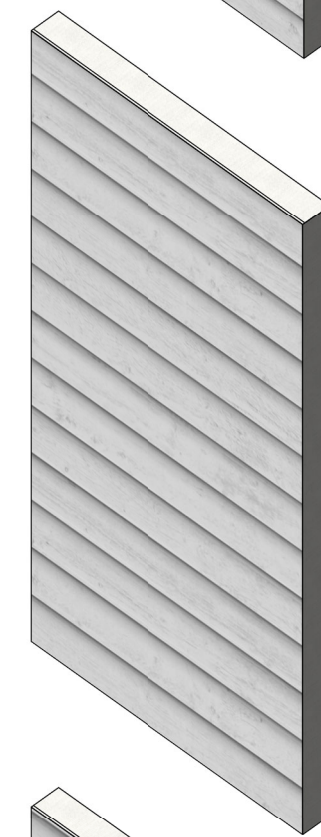
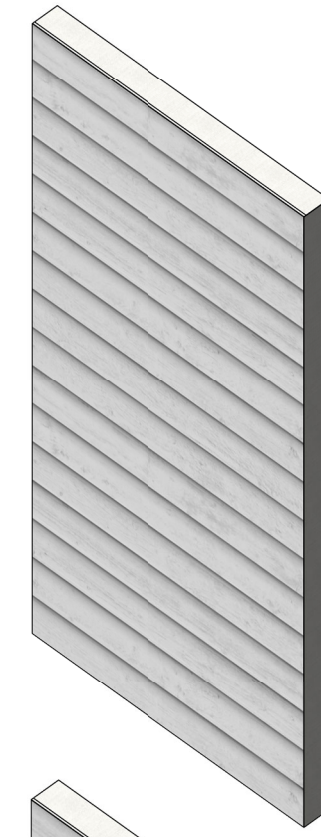

5.84

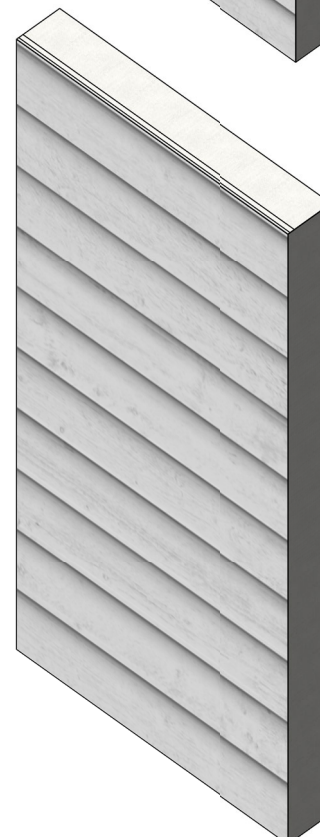
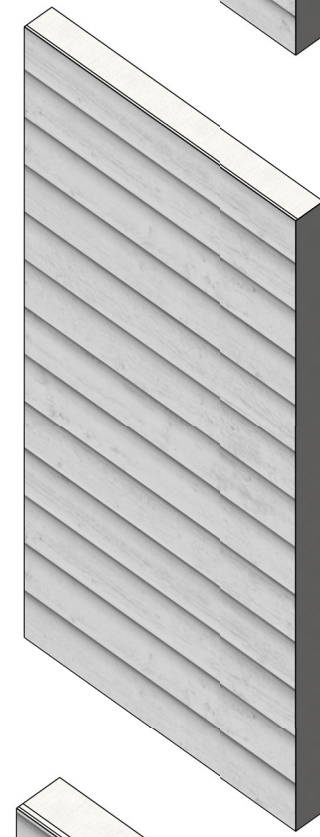
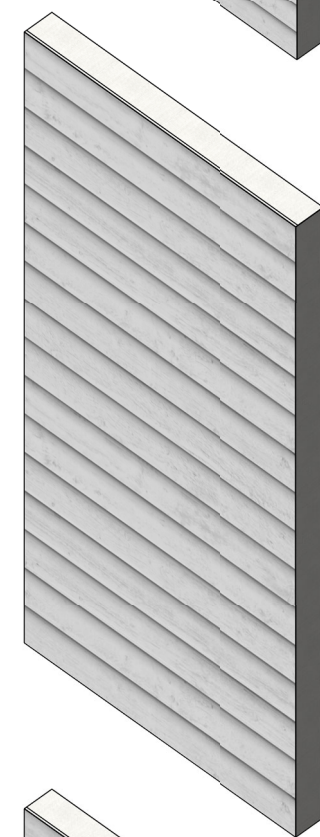
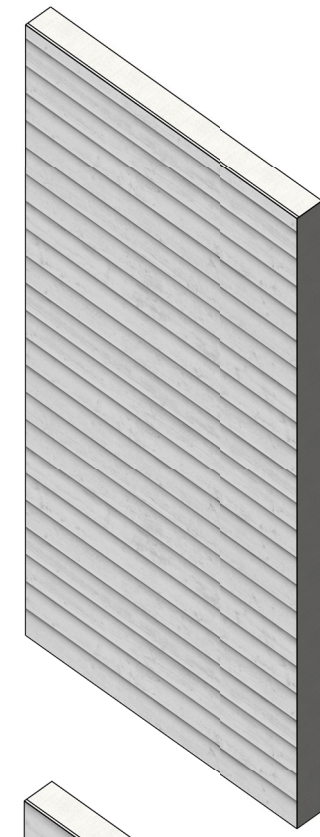

2x4 Direct to Stud

2x4 w/WSP

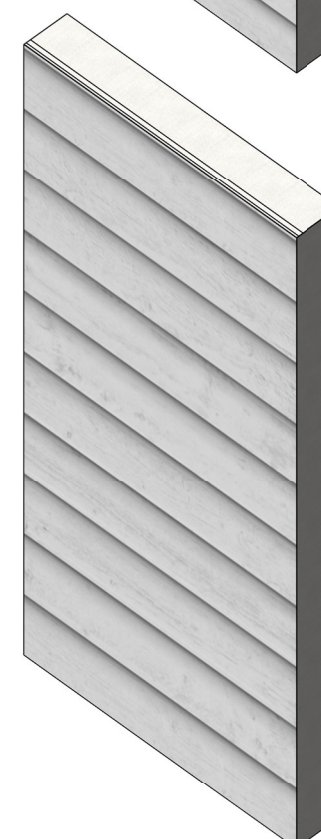
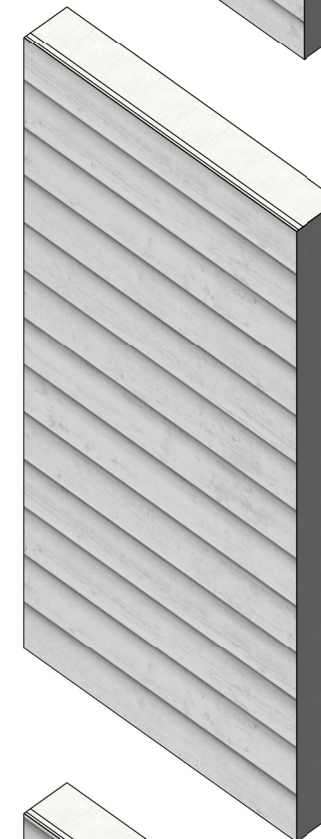
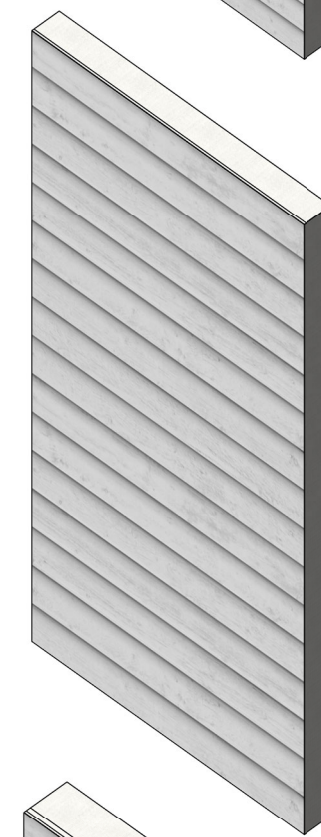
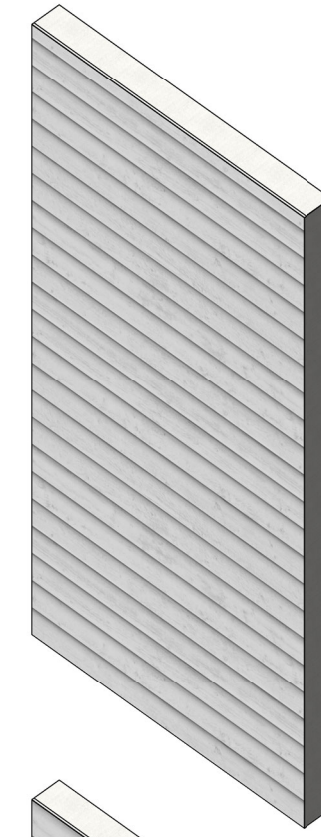

Wall Construction

2x4 w/WeatherLogic®

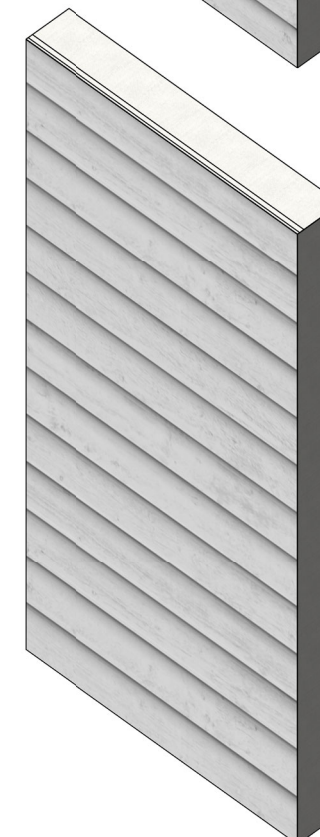
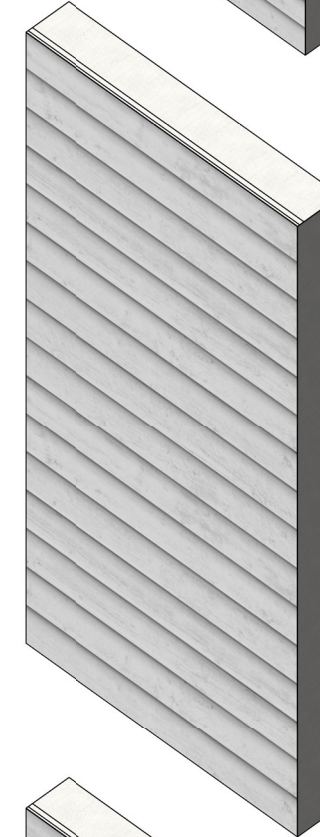
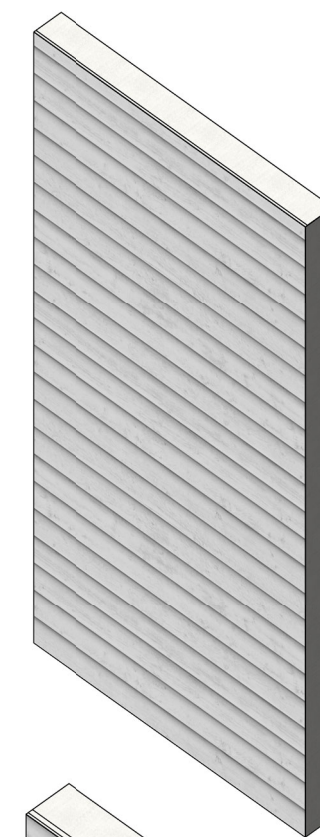

2x4 w/Exterior Insulation

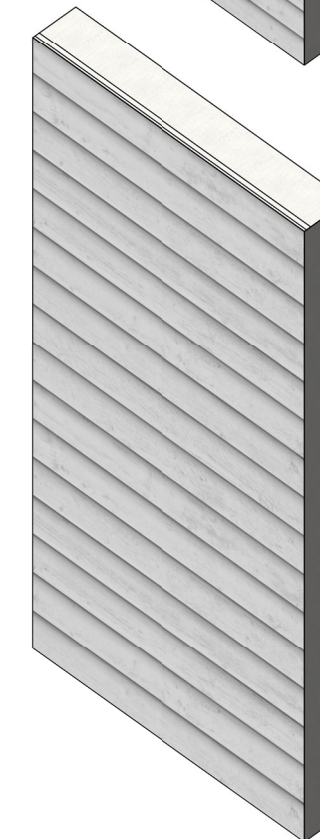
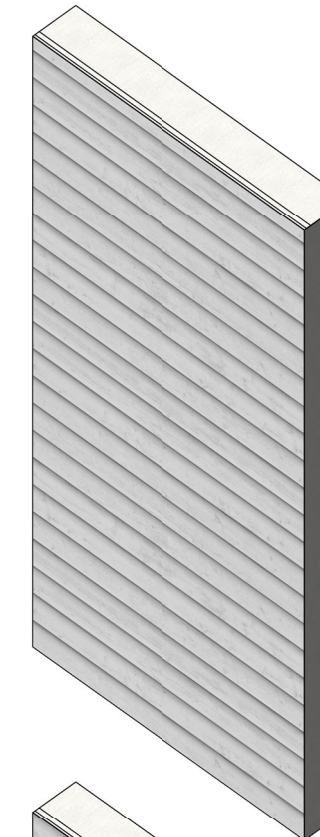

2x4 w/Exterior Insulation & WeatherLogic®

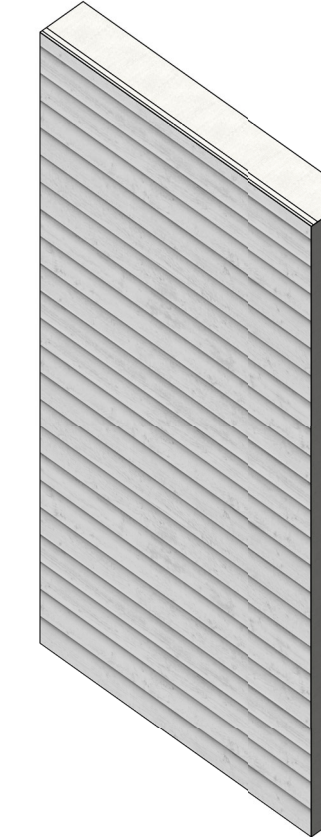

1 Wall Types 3 - 76 Series Cedar Texture Lap (Fiber)



LP® SmartSide®

Lap Siding
76 Series Cedar Texture
Lap (Fiber)

LPCorp.com
800-450-6106

Notes:
These drawings are general illustrations and are not to be used as final construction details. Check your local building codes before installing siding to confirm whether wood structural panel wall sheathing is required. Follow all manufacturer instructions and applicable building codes.

For additional information, go to lpcorp.com/resources/product-literature

For realistic texture previews, place the "LP Building Solutions Product Textures" folder in your C:\ directory and then reopen this file.

©2019 Louisiana-Pacific Corporation.
All rights reserved.

Scale



LP® SmartSide®

Lap Siding
76 Series SmartLock Cedar
Texture Lap (Strand)

LP Corp.com
800-450-6106

Notes:
These drawings are general illustrations and are not to be used as final construction details. Check your local building codes before installing siding to confirm whether wood structural panel wall sheathing is required. Follow all manufacturer instructions and applicable building codes.

For additional information, go to lpcorp.com/resources/product-literature

For realistic texture previews, place the "LP Building Solutions Product Textures" folder in your C:\ directory and then reopen this file.

©2019 Louisiana-Pacific Corporation.
All rights reserved.

Scale

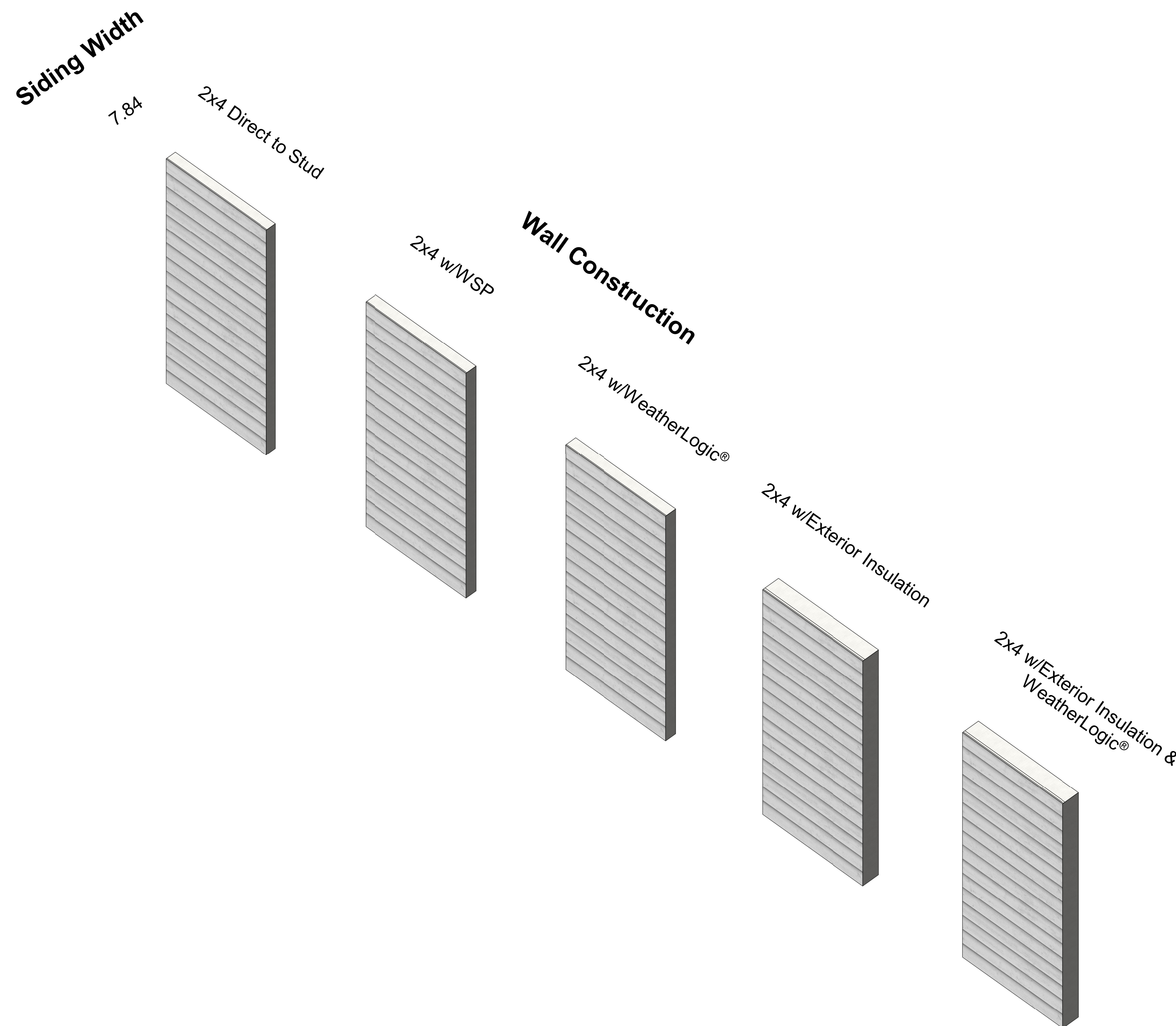

1 Wall Types 4 - 76 Series SmartLock Cedar Texture Lap (Strand)



LP® SmartSide®

Lap Siding
120 Series Self-Aligning
Cedar Texture Lap (Fiber)

LPCorp.com
800-450-6106

Notes:
These drawings are general illustrations and are not to be used as final construction details. Check your local building codes before installing siding to confirm whether wood structural panel wall sheathing is required. Follow all manufacturer instructions and applicable building codes.

For additional information, go to lpcorp.com/resources/product-literature

For realistic texture previews, place the "LP Building Solutions Product Textures" folder in your C:\ directory and then reopen this file.

©2019 Louisiana-Pacific Corporation.
All rights reserved.

Scale

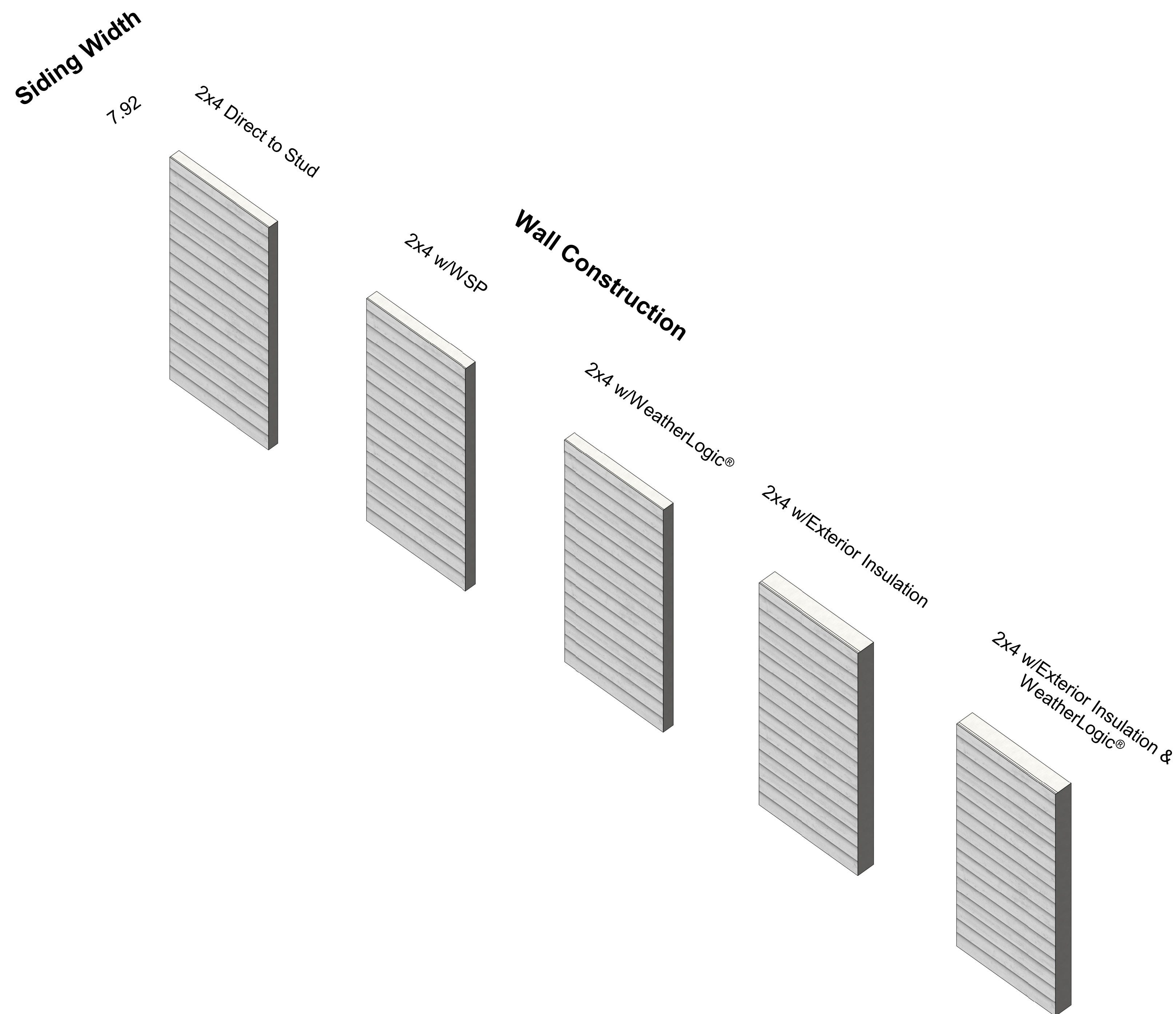

1 Wall Types 5 - 120 Series Self-Aligning Cedar Texture Lap (Fiber)



LP® SmartSide®

Lap Siding
38 Series Smooth Finish
Lap (Strand)

LP Corp.com
800-450-6106

Notes:
These drawings are general illustrations and are not to be used as final construction details. Check your local building codes before installing siding to confirm whether wood structural panel wall sheathing is required. Follow all manufacturer instructions and applicable building codes.

For additional information, go to lpcorp.com/resources/product-literature

For realistic texture previews, place the "LP Building Solutions Product Textures" folder in your C:\ directory and then reopen this file.

©2019 Louisiana-Pacific Corporation.
All rights reserved.

Scale

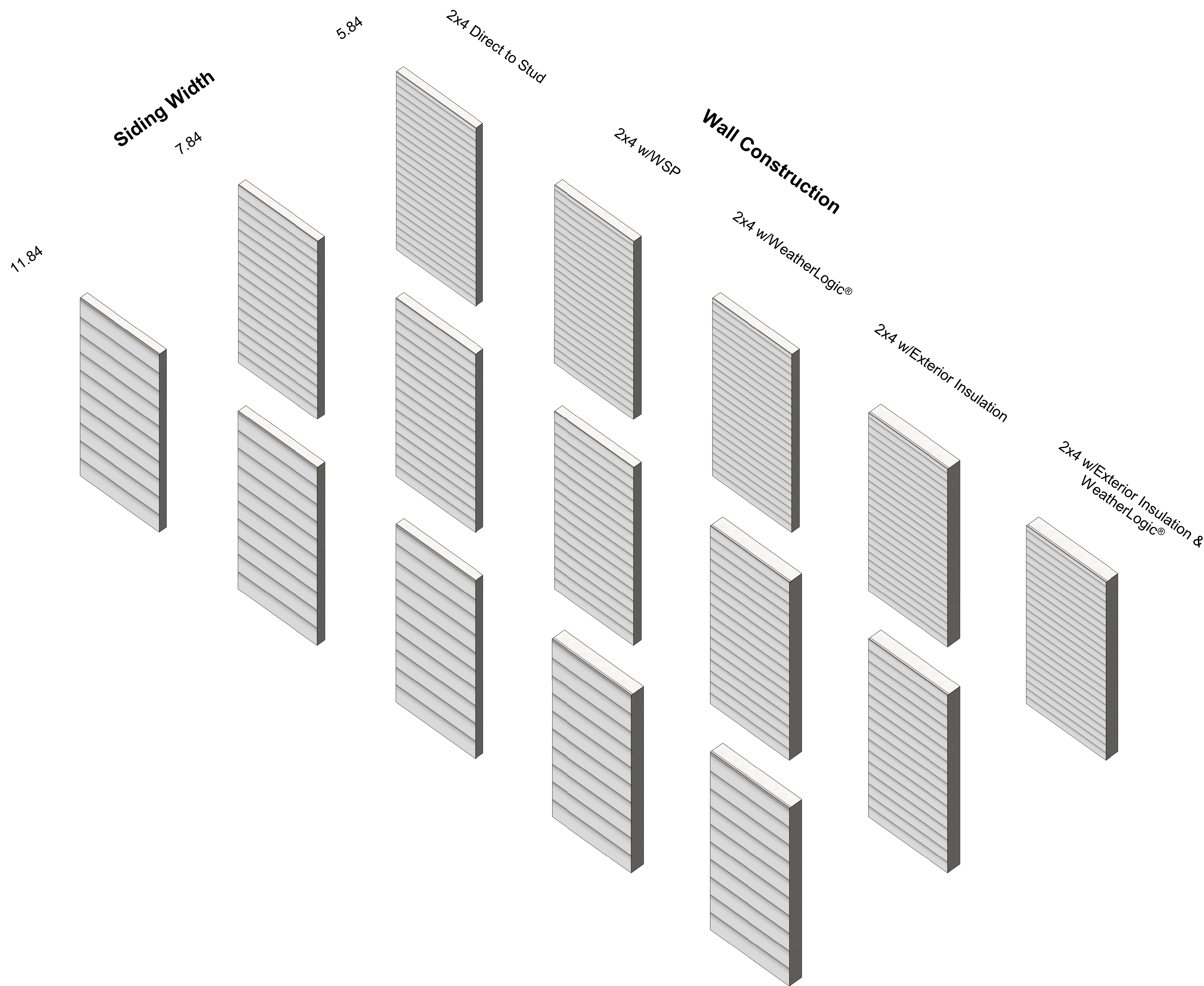

1 Wall Types 6 - 38 Series Smooth Finish Lap (Strand)



LP® SmartSide®

Lap Siding
Colonial Beaded Sequoia
Texture Lap (Fiber)

LP Corp.com
800-450-6106

Notes:
These drawings are general illustrations and are not to be used as final construction details. Check your local building codes before installing siding to confirm whether wood structural panel wall sheathing is required. Follow all manufacturer instructions and applicable building codes.

For additional information, go to lpcorp.com/resources/product-literature

For realistic texture previews, place the "LP Building Solutions Product Textures" folder in your C:\ directory and then reopen this file.

©2019 Louisiana-Pacific Corporation.
All rights reserved.

Scale

Siding Width
7.94

2x4 Direct to Stud

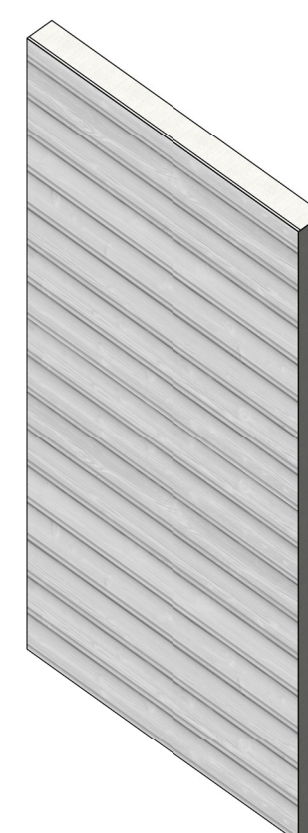

2x4 w/WSP

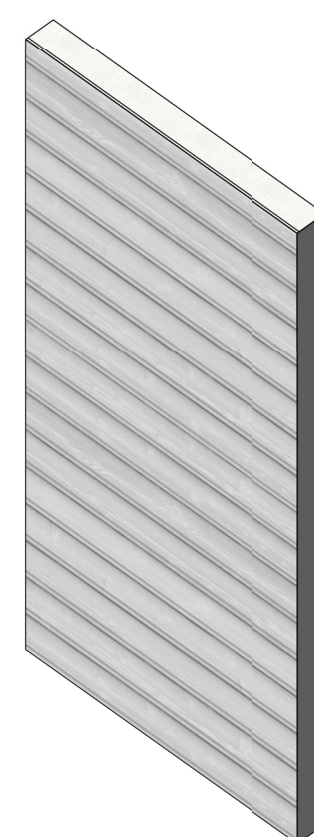

Wall Construction

2x4 w/WeatherLogic®

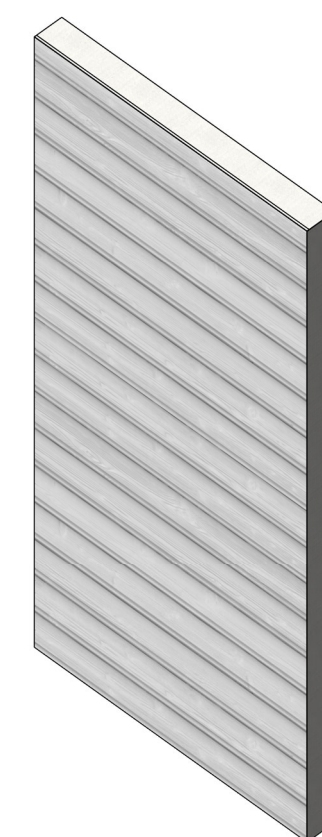

2x4 w/Exterior Insulation

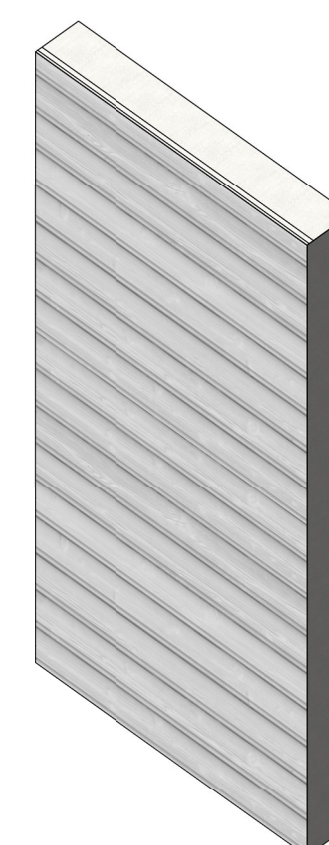

2x4 w/Exterior Insulation & WeatherLogic®

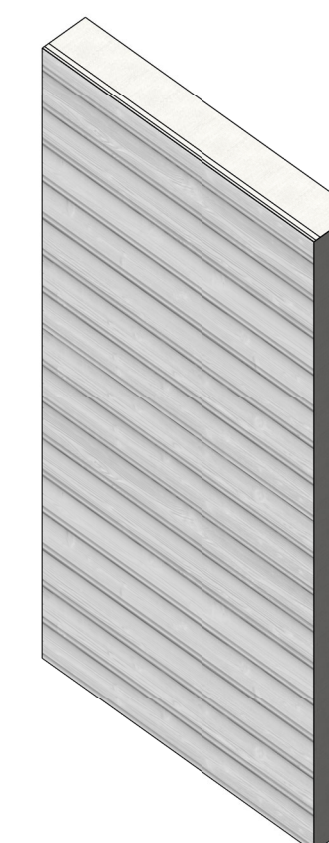

1 Wall Types 7 - Colonial Beaded Sequoia Texture Lap (Fiber)



LP® SmartSide®

Lap Siding
Colonial Beaded Smooth
Finish Lap (Fiber)

LPCorp.com
800-450-6106

Notes:
These drawings are general illustrations and are not to be used as final construction details. Check your local building codes before installing siding to confirm whether wood structural panel wall sheathing is required. Follow all manufacturer instructions and applicable building codes.

For additional information, go to lpcorp.com/resources/product-literature

For realistic texture previews, place the "LP Building Solutions Product Textures" folder in your C:\ directory and then reopen this file.

©2019 Louisiana-Pacific Corporation.
All rights reserved.

Scale

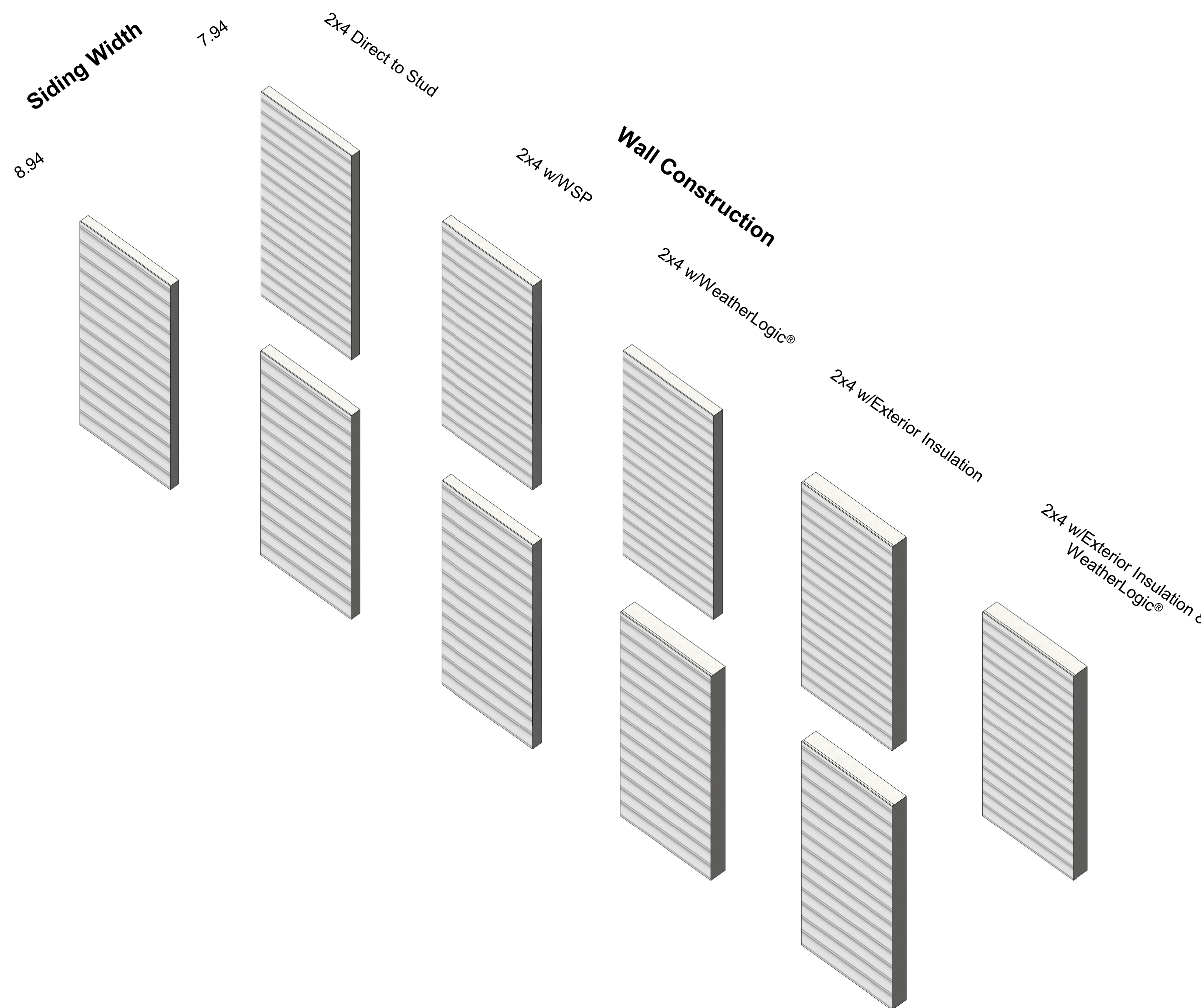

1 Wall Types 8 - Colonial Beaded Smooth Finish Lap (Fiber)



LP® SmartSide®

Lap Siding
Bold Profile Triple 4" Cedar
Texture Lap (Fiber)

LP Corp.com
800-450-6106

Notes:
These drawings are general illustrations and are not to be used as final construction details. Check your local building codes before installing siding to confirm whether wood structural panel wall sheathing is required. Follow all manufacturer instructions and applicable building codes.

For additional information, go to lpcorp.com/resources/product-literature

For realistic texture previews, place the "LP Building Solutions Product Textures" folder in your C:\ directory and then reopen this file.

©2019 Louisiana-Pacific Corporation.
All rights reserved.

Scale

Siding Width
11.86

2x4 Direct to Stud

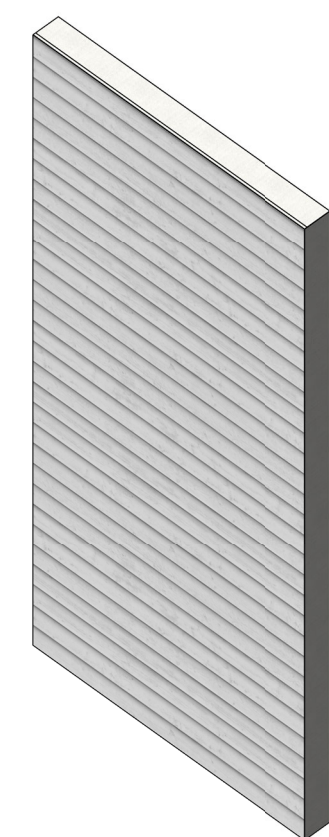

2x4 w/WSP

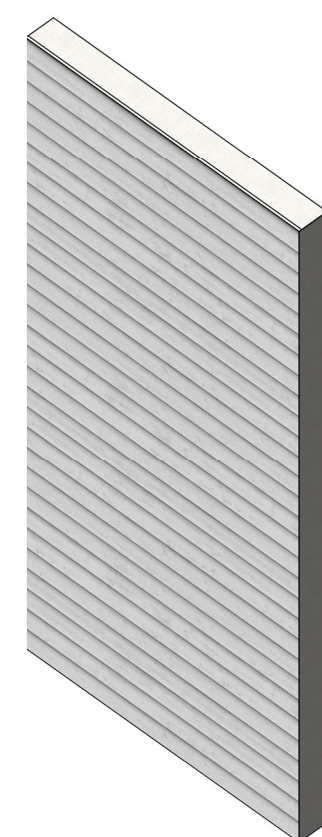

Wall Construction

2x4 w/WeatherLogic®

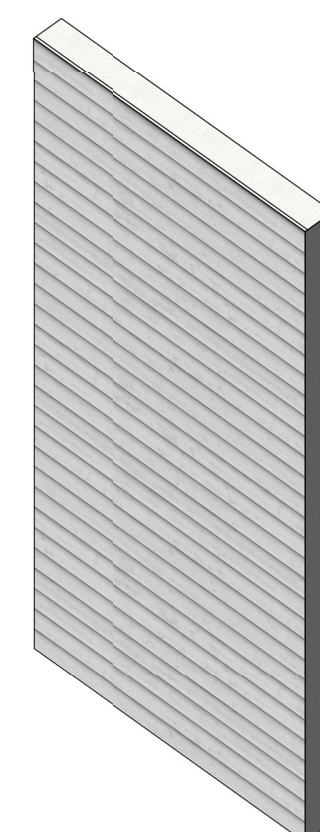

2x4 w/Exterior Insulation

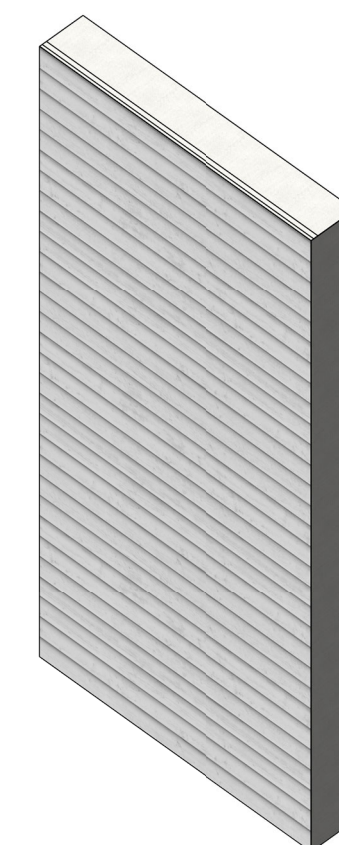

2x4 w/Exterior Insulation & WeatherLogic®

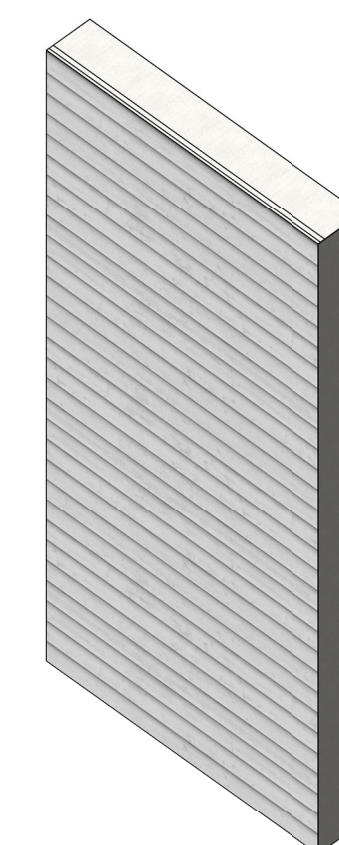

1 Wall Types 9 - Bold Profile Triple 4" Cedar Texture Lap (Fiber)



LP® SmartSide®

Lap Siding
Bold Profile Double 5"
Cedar Texture Lap (Fiber)

LP Corp.com
800-450-6106

Notes:
These drawings are general illustrations and are not to be used as final construction details. Check your local building codes before installing siding to confirm whether wood structural panel wall sheathing is required. Follow all manufacturer instructions and applicable building codes.

For additional information, go to lpcorp.com/resources/product-literature

For realistic texture previews, place the "LP Building Solutions Product Textures" folder in your C:\ directory and then reopen this file.

©2019 Louisiana-Pacific Corporation.
All rights reserved.

Scale

Siding Width
11.86

2x4 Direct to Stud

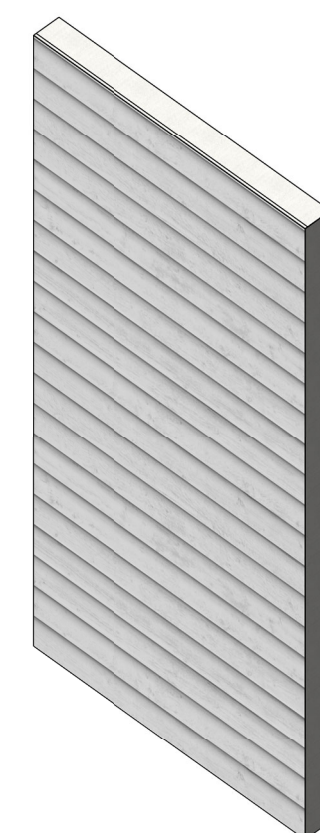

2x4 w/WSP

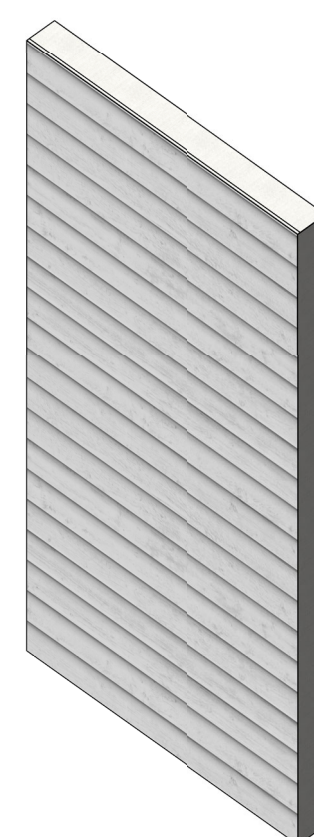

Wall Construction

2x4 w/WeatherLogic®

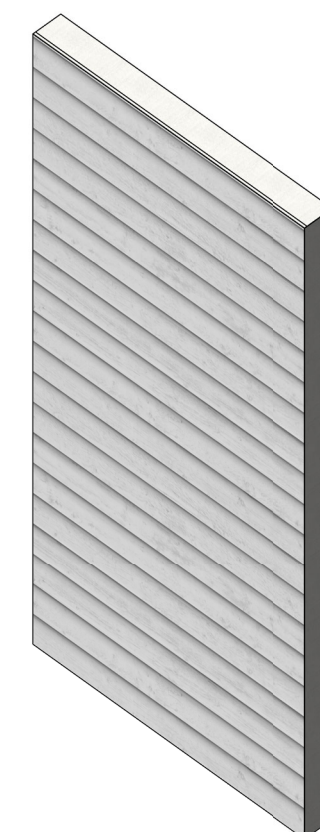

2x4 w/Exterior Insulation

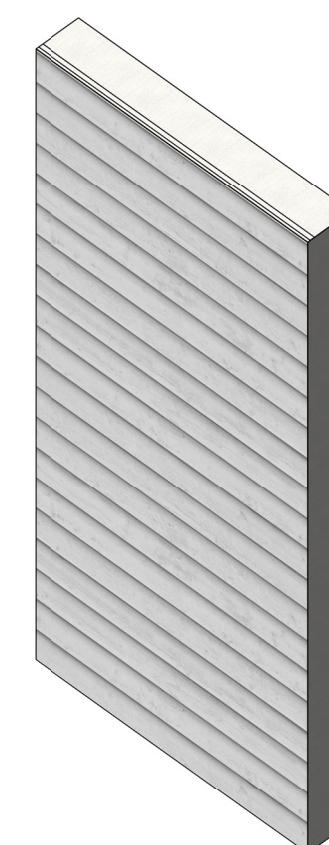

2x4 w/Exterior Insulation & WeatherLogic®

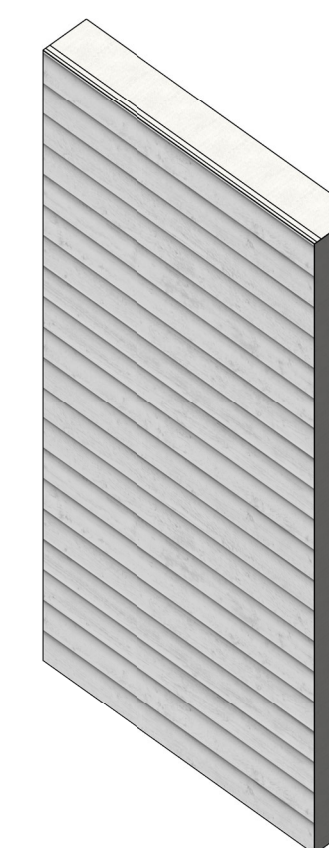

1 Wall Types 10 - Bold Profile Double 5" Cedar Texture Lap (Fiber)



LP® SmartSide®

Lap Siding
Bold Profile Quad 4" Cedar
Texture Lap (Fiber)

LP Corp.com
800-450-6106

Notes:
These drawings are general illustrations and are not to be used as final construction details. Check your local building codes before installing siding to confirm whether wood structural panel wall sheathing is required. Follow all manufacturer instructions and applicable building codes.

For additional information, go to lpcorp.com/resources/product-literature

For realistic texture previews, place the "LP Building Solutions Product Textures" folder in your C:\ directory and then reopen this file.

©2019 Louisiana-Pacific Corporation.
All rights reserved.

Scale

Siding Width
15.94

2x4 Direct to Stud

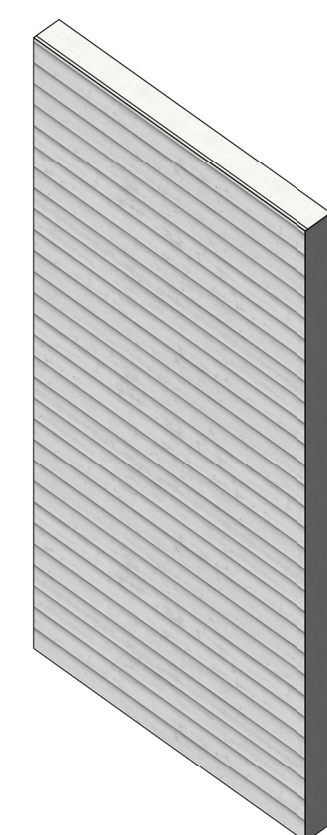

2x4 w/WSP

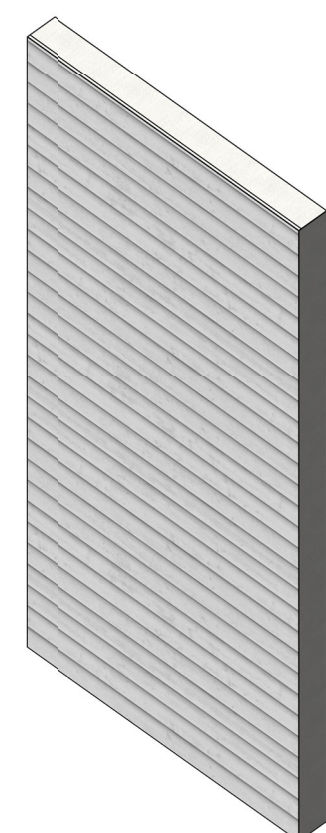

Wall Construction

2x4 w/WeatherLogic®

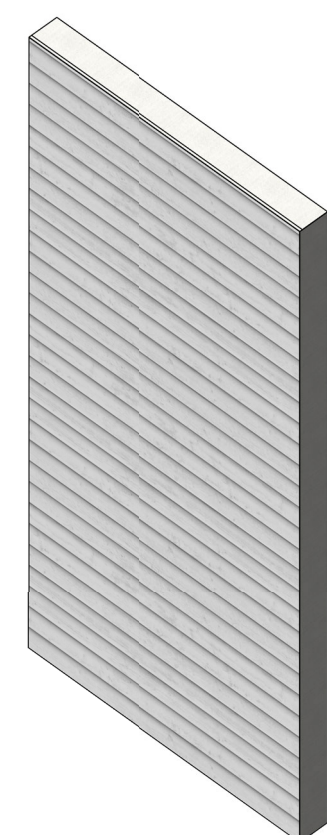

2x4 w/Exterior Insulation

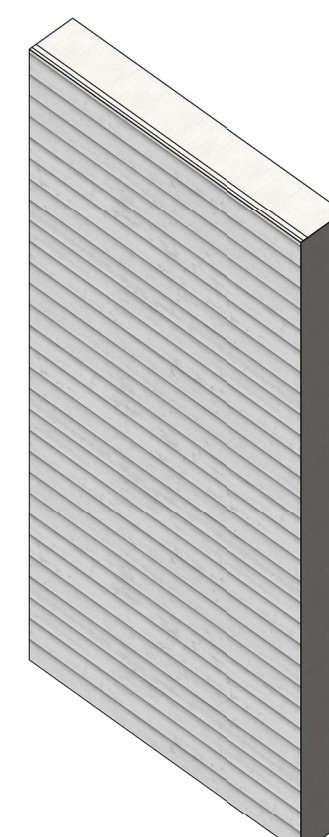

2x4 w/Exterior Insulation & WeatherLogic®

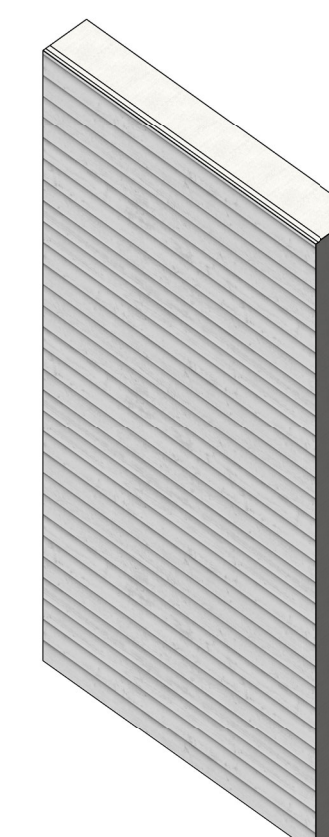

1 Wall Types 11 - Bold Profile Quad 4" Cedar Texture Lap (Fiber)



LP® SmartSide®

Lap Siding
Bold Profile Triple 5" Cedar
Texture Lap (Fiber)

LPCorp.com
800-450-6106

Notes:
These drawings are general illustrations and are not to be used as final construction details. Check your local building codes before installing siding to confirm whether wood structural panel wall sheathing is required. Follow all manufacturer instructions and applicable building codes.

For additional information, go to lpcorp.com/resources/product-literature

For realistic texture previews, place the "LP Building Solutions Product Textures" folder in your C:\ directory and then reopen this file.

©2019 Louisiana-Pacific Corporation.
All rights reserved.

Scale

Siding Width
15.94

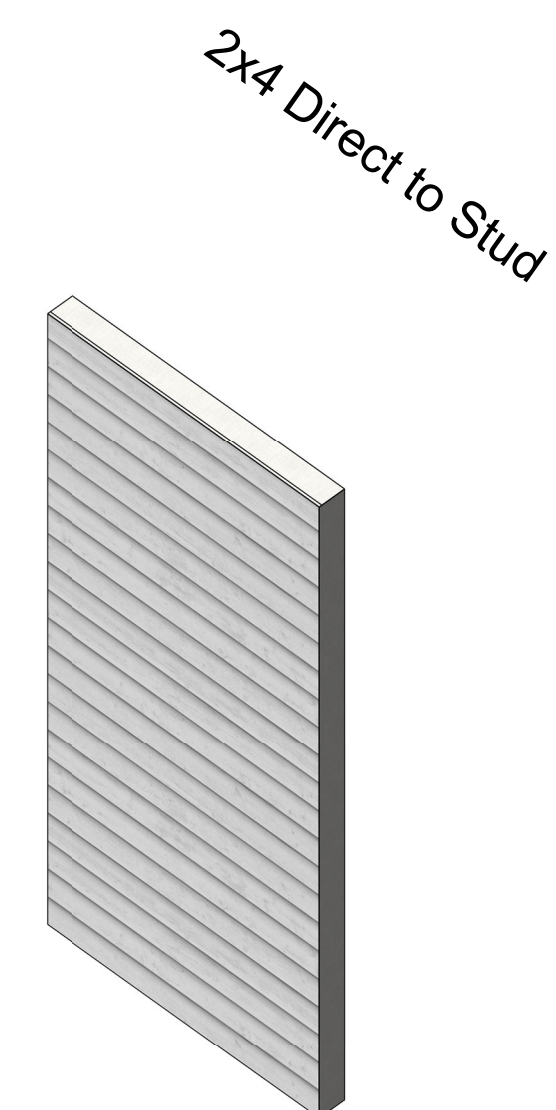

2x4 Direct to Stud

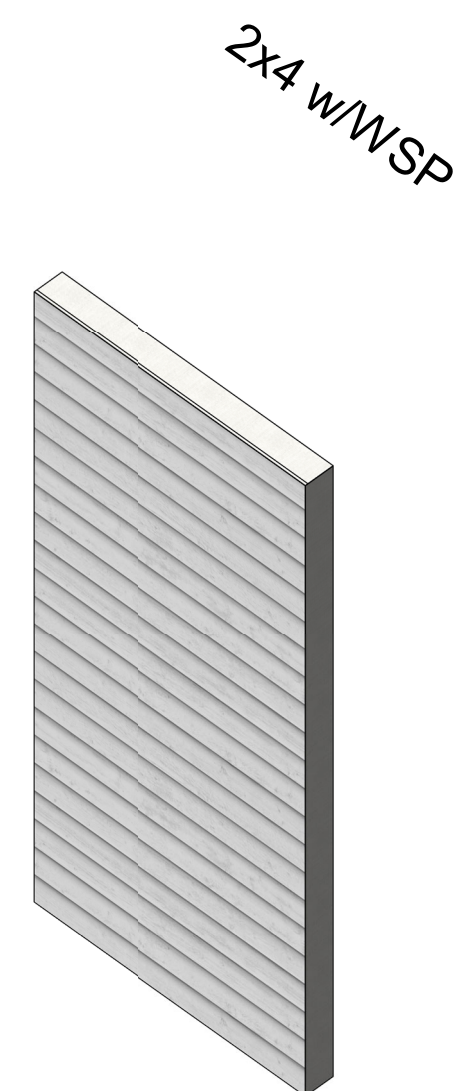

2x4 w/WSP

Wall Construction

2x4 w/WeatherLogic®

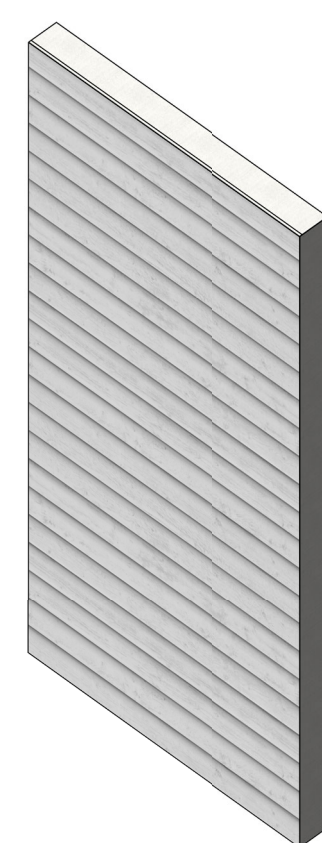

2x4 w/Exterior Insulation

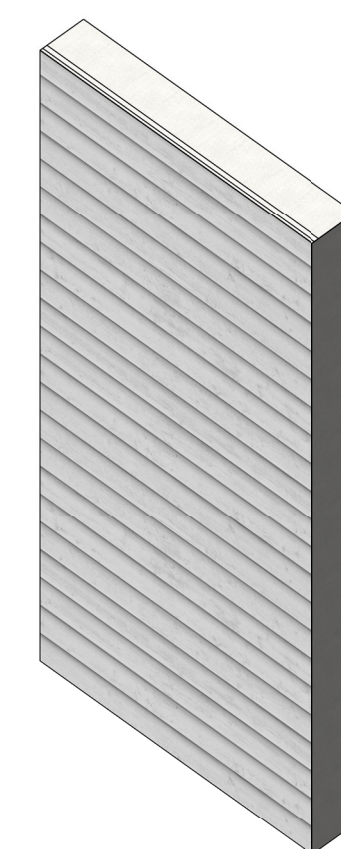

2x4 w/Exterior Insulation & WeatherLogic®

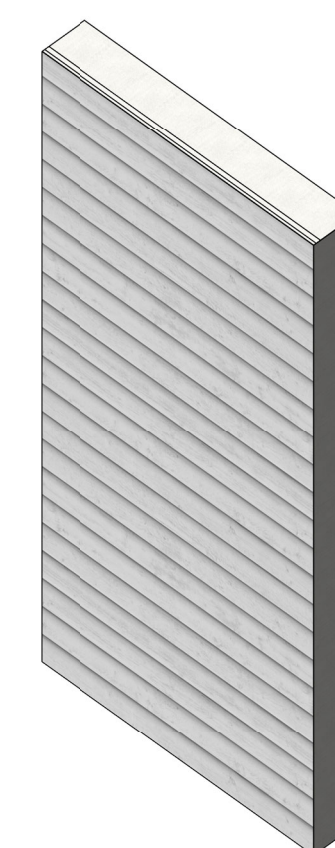

① Wall Types 12 - Bold Profile Triple 5" Cedar Texture Lap (Fiber)



Siding Width
15.94

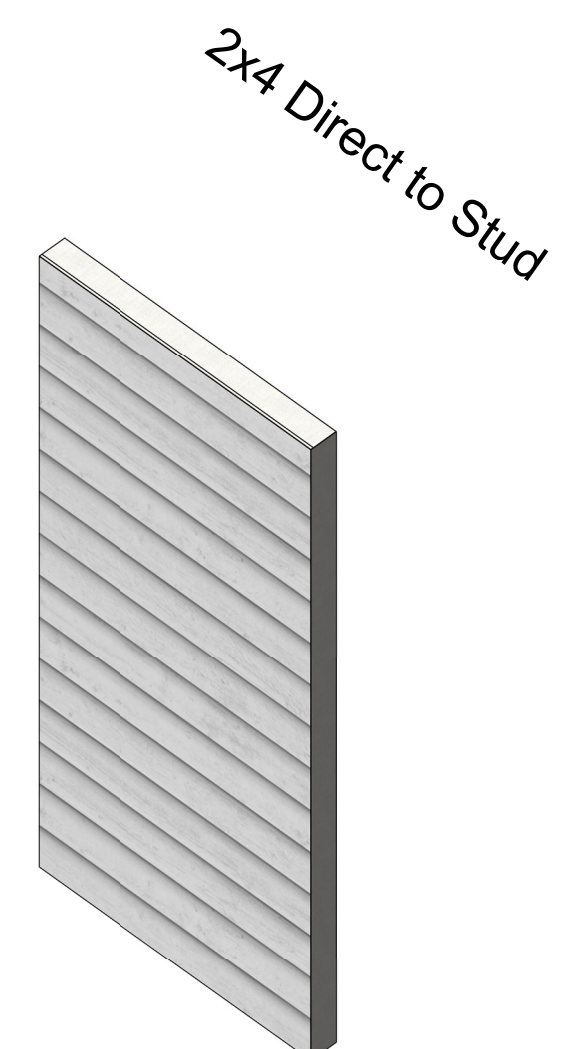

2x4 Direct to Stud

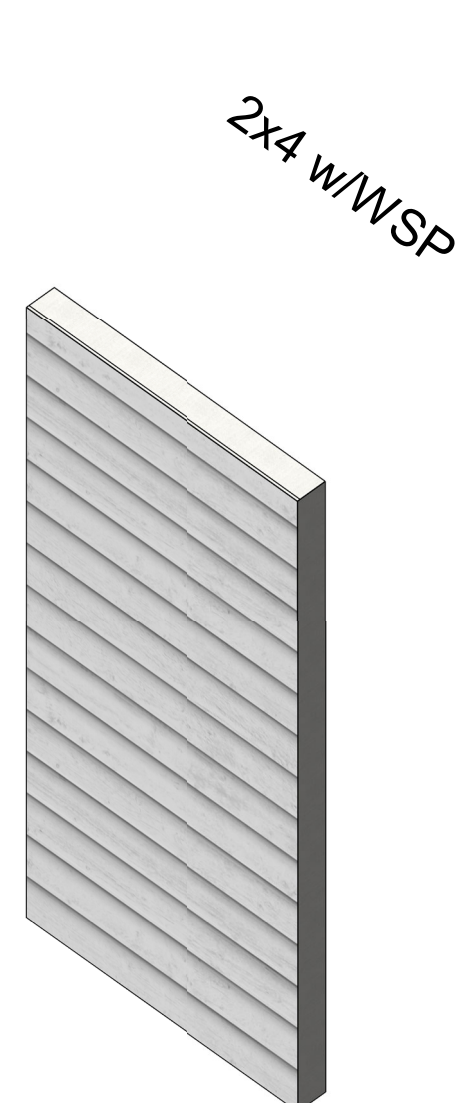

2x4 w/WSP

Wall Construction

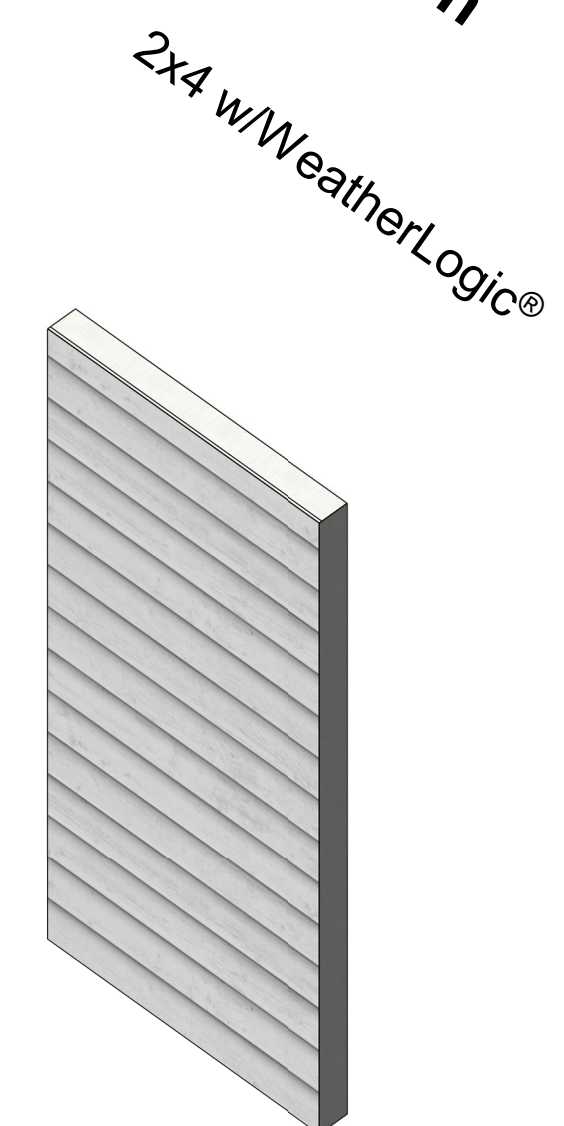

2x4 w/WeatherLogic®

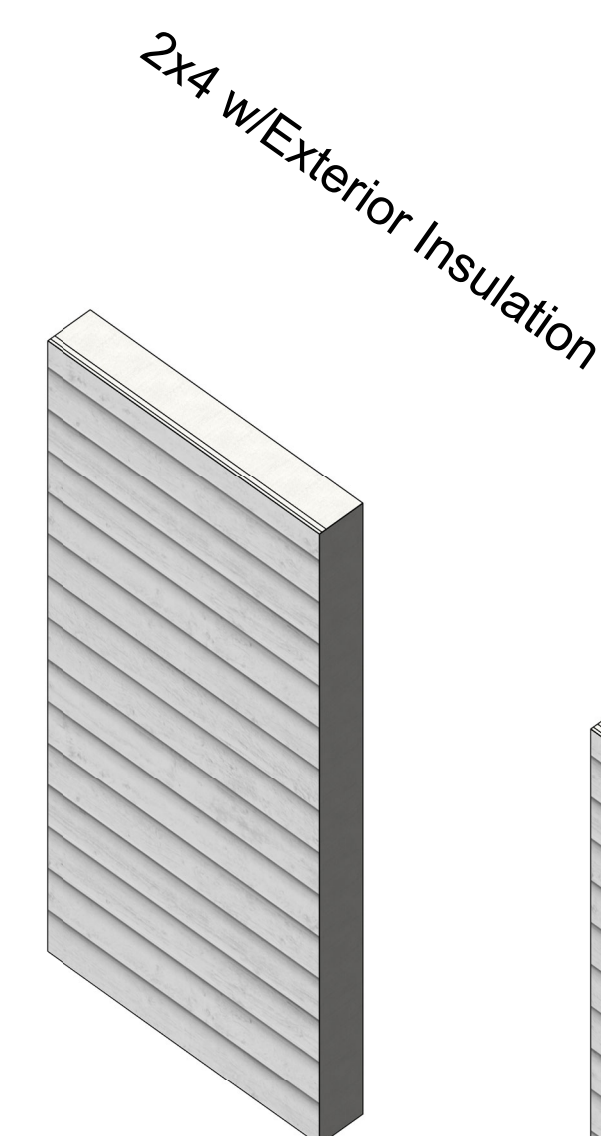

2x4 w/Exterior Insulation

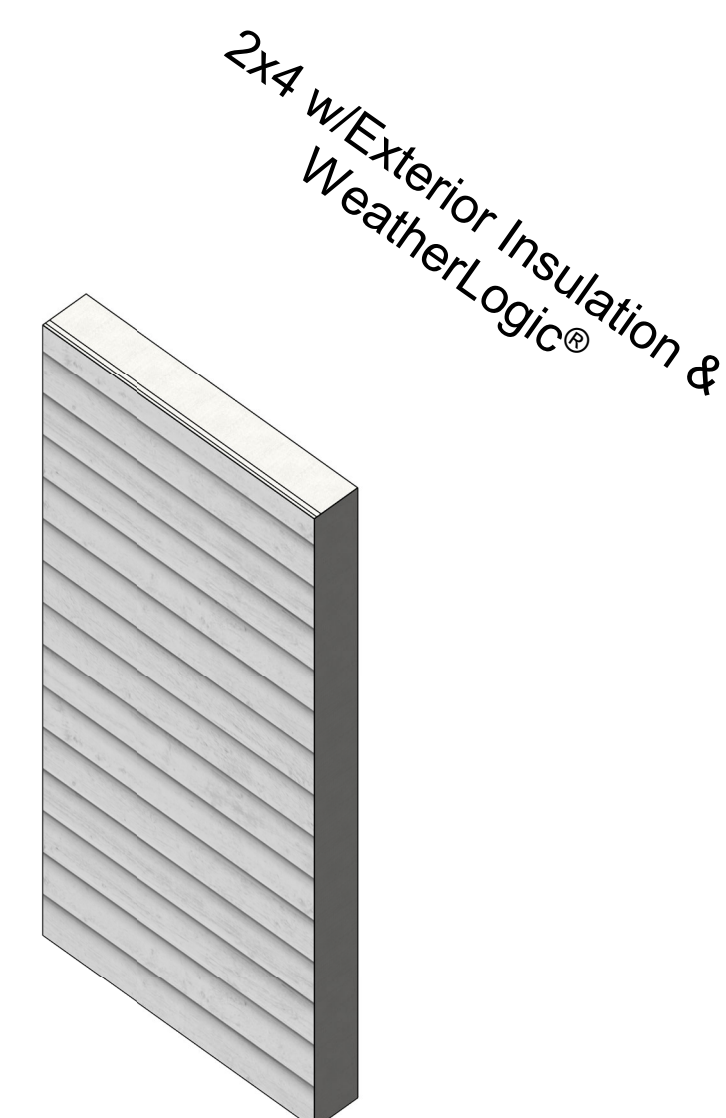

2x4 w/Exterior Insulation & WeatherLogic®

1 Wall Types 13 - Bold Profile Double 8" Cedar Texture Lap (Fiber)

LP® SmartSide®
Lap Siding
Bold Profile Double 8"
Cedar Texture Lap (Fiber)

LP Corp.com
800-450-6106

Notes:
These drawings are general illustrations and are not to be used as final construction details. Check your local building codes before installing siding to confirm whether wood structural panel wall sheathing is required. Follow all manufacturer instructions and applicable building codes.

For additional information, go to lpcorp.com/resources/product-literature

For realistic texture previews, place the "LP Building Solutions Product Textures" folder in your C:\ directory and then reopen this file.

©2019 Louisiana-Pacific Corporation.
All rights reserved.

Scale



LP® SmartSide®

Lap Siding
76 Series Smooth Finish
Lap (Fiber)

LPCorp.com
800-450-6106

Notes:
These drawings are general illustrations and are not to be used as final construction details. Check your local building codes before installing siding to confirm whether wood structural panel wall sheathing is required. Follow all manufacturer instructions and applicable building codes.

For additional information, go to lpcorp.com/resources/product-literature

For realistic texture previews, place the "LP Building Solutions Product Textures" folder in your C:\ directory and then reopen this file.

©2019 Louisiana-Pacific Corporation.
All rights reserved.

Scale

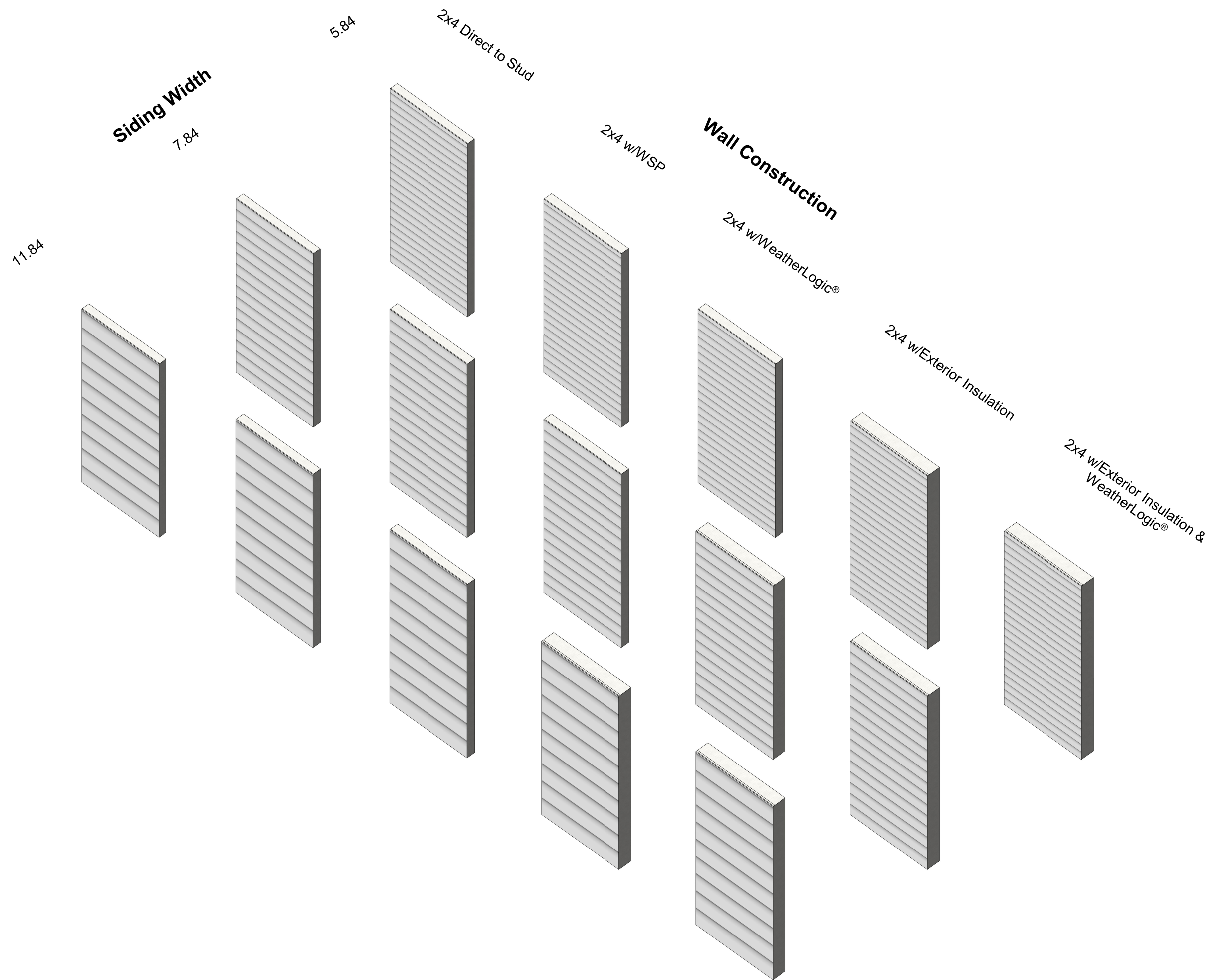

① Wall Types 14 - 76 Series Smooth Finish Lap (Fiber)



LP® SmartSide®

Lap Siding
 Details - Direct to Stud,
 WSP, & WeatherLogic®

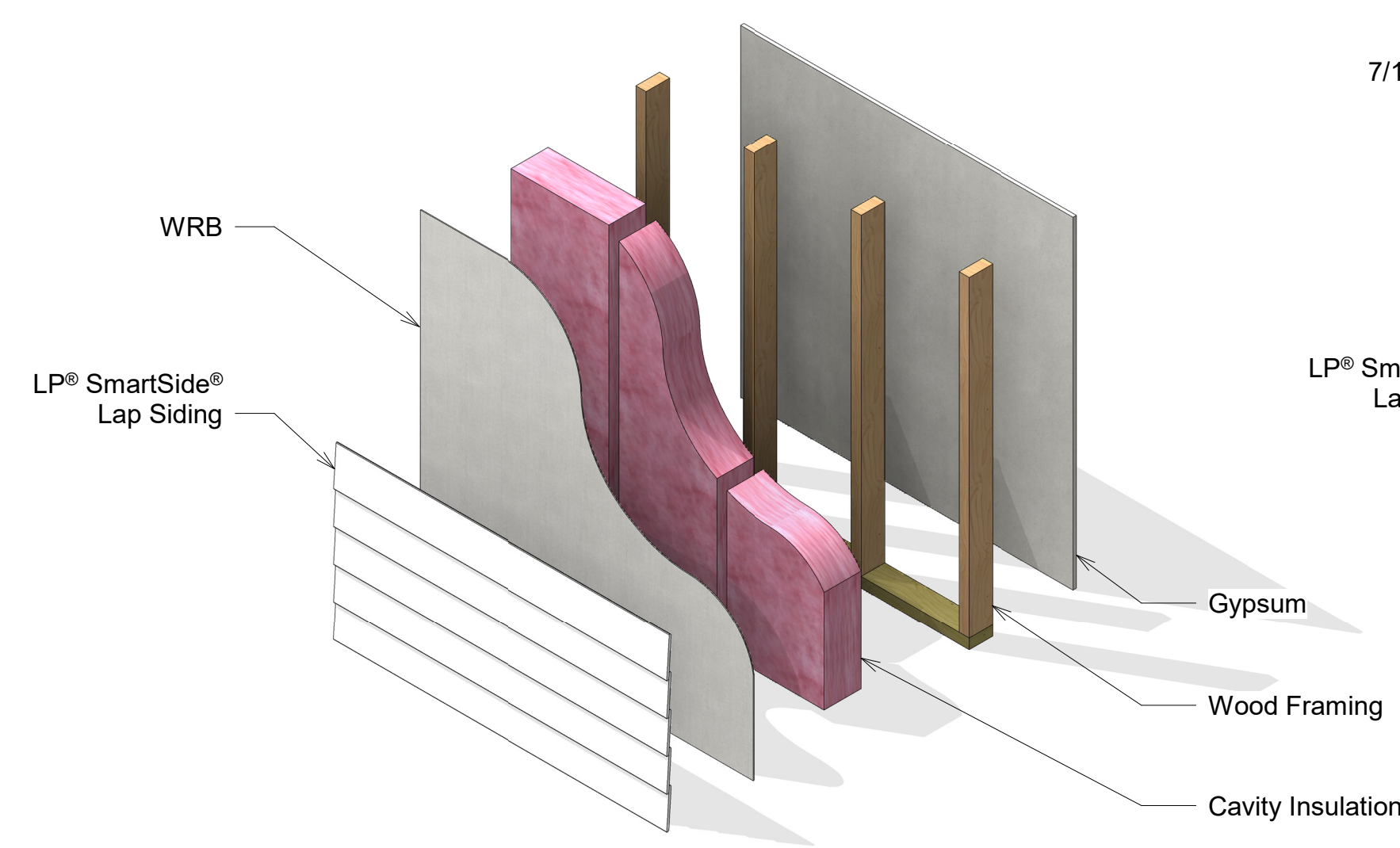

① Exploded Isometric 1 - Direct to Stud Application

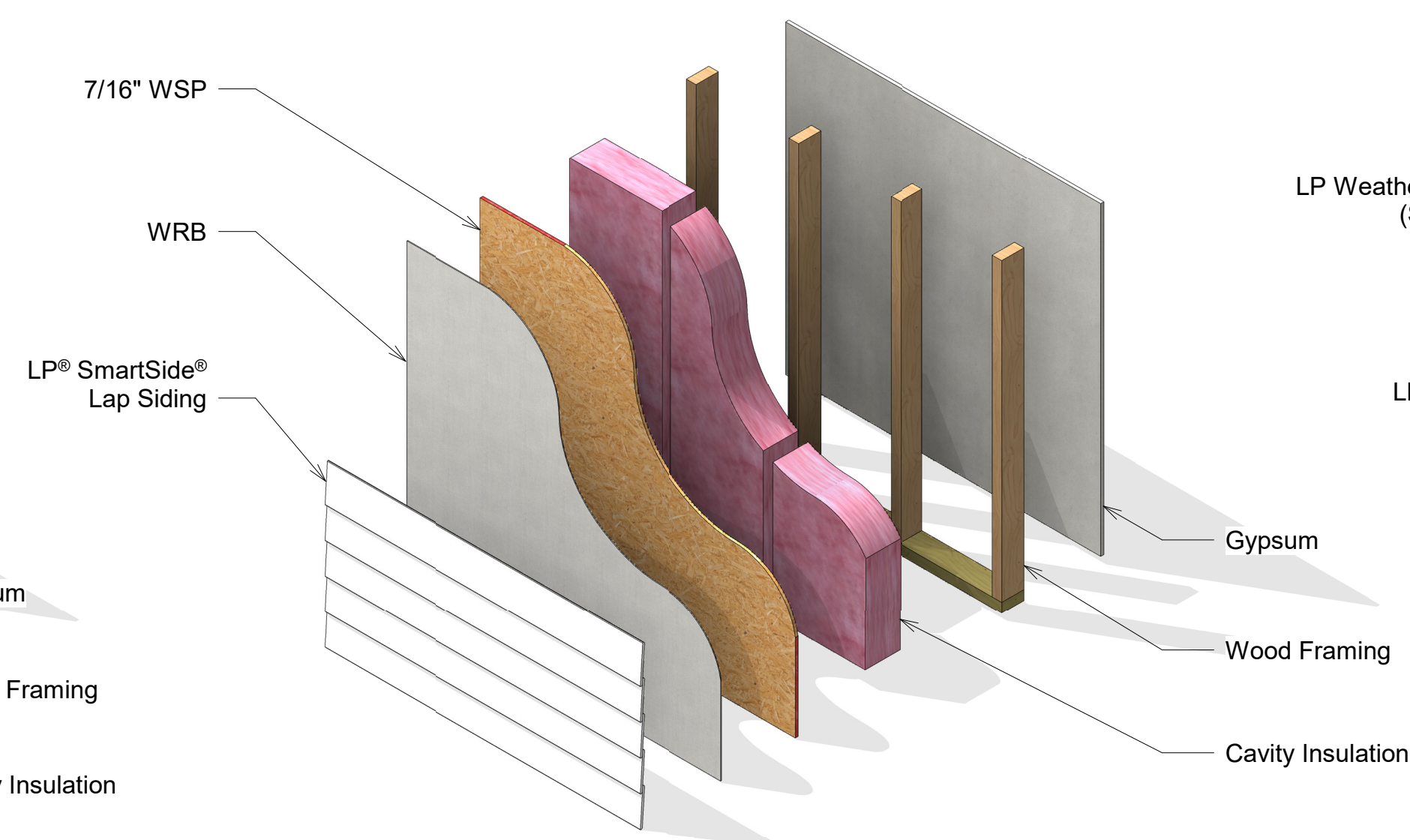

② Exploded Isometric 2 - WSP Application

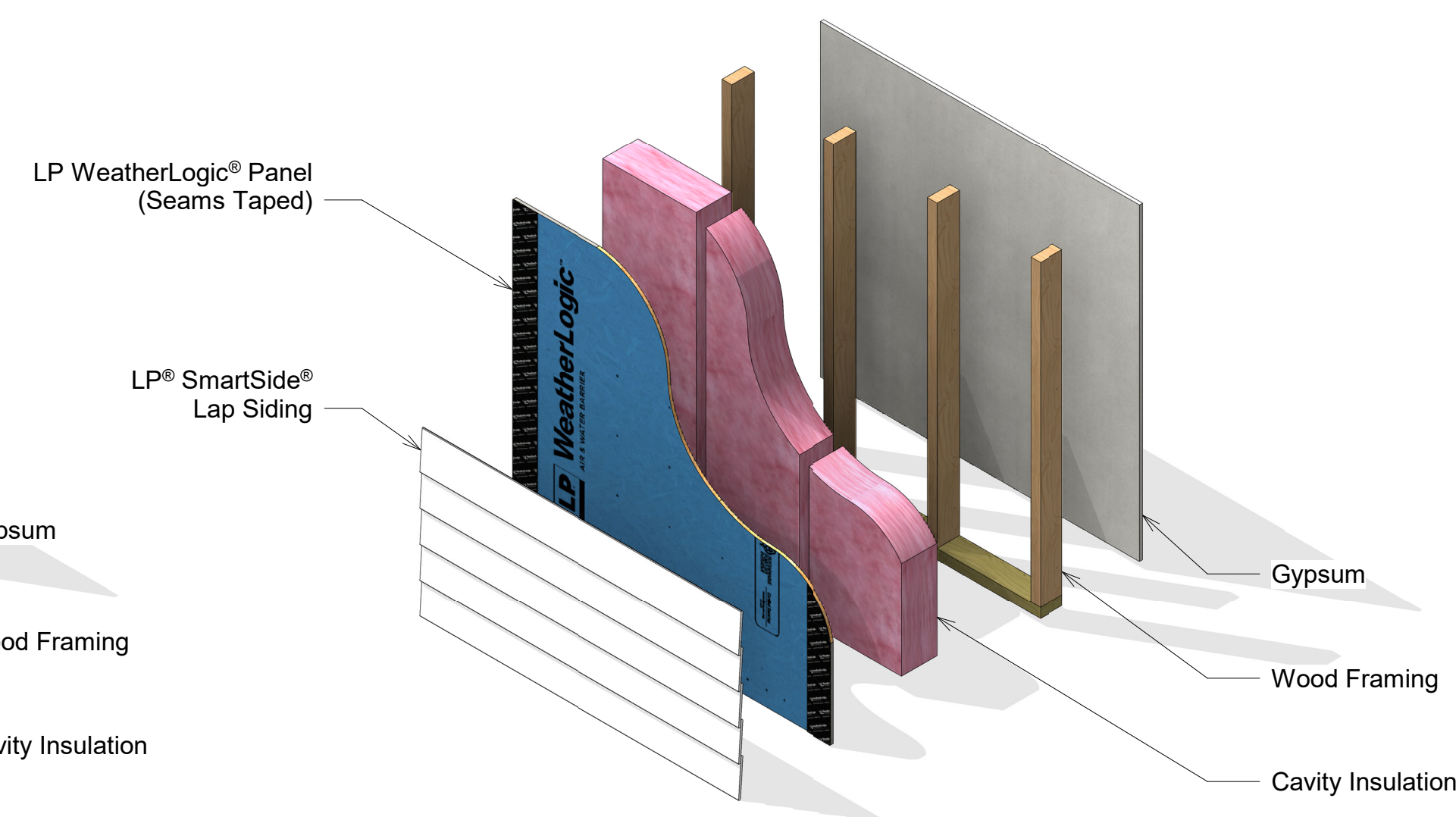

③ Exploded Isometric 3 - WeatherLogic® Application

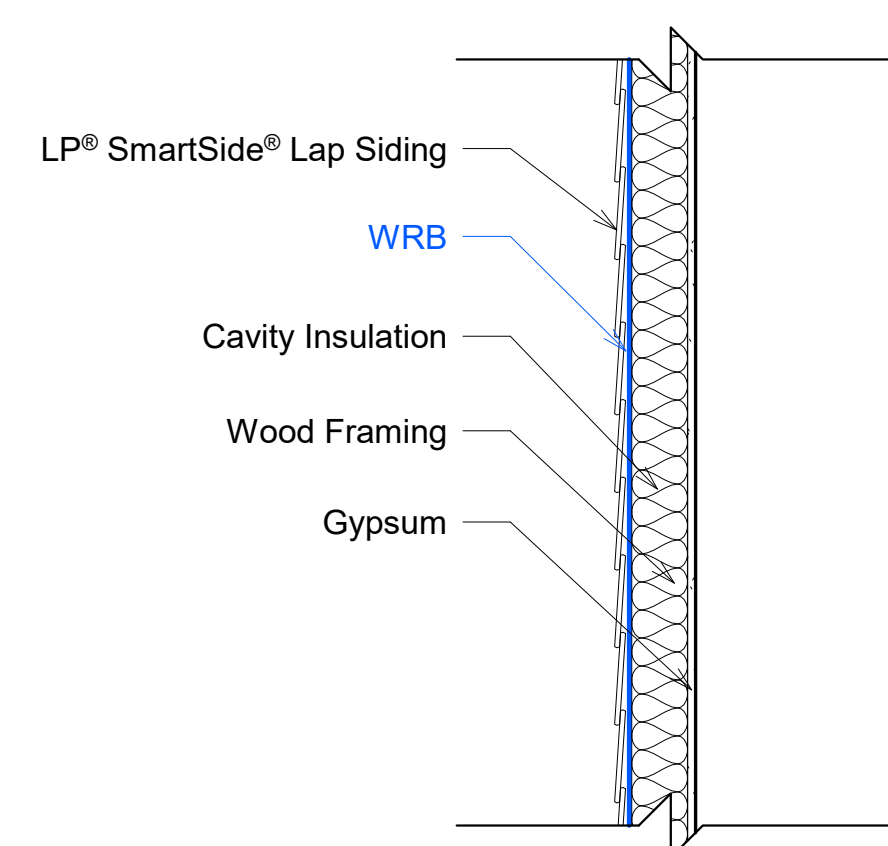

④ Section 1 - Direct to Stud Application
 1" = 1'-0"

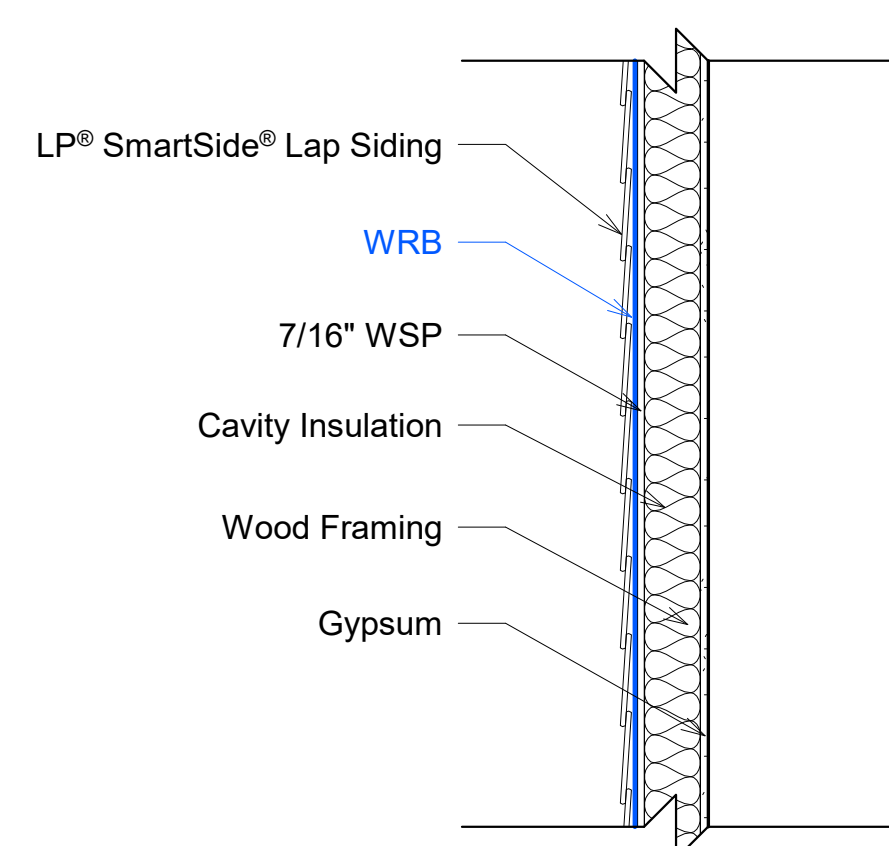

⑤ Section 2 - WSP Application
 1" = 1'-0"

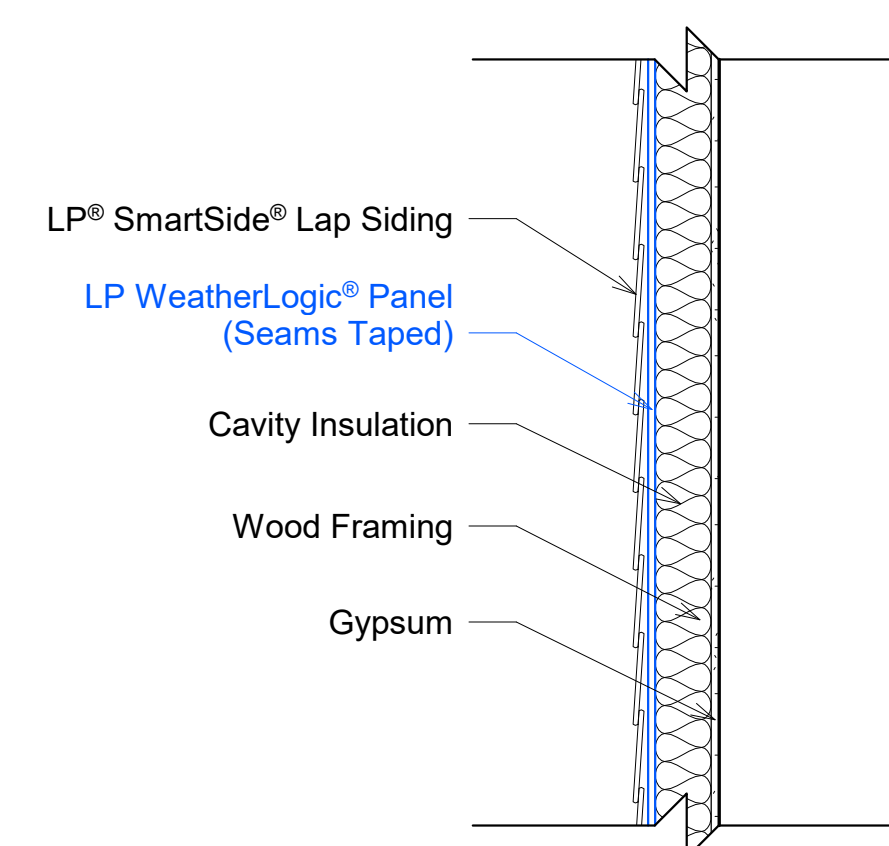

⑥ Section 3 - WeatherLogic® Application
 1" = 1'-0"

LPCorp.com
 800-450-6106

Notes:
 These drawings are general illustrations and are not to be used as final construction details. Check your local building codes before installing siding to confirm whether wood structural panel wall sheathing is required. Follow all manufacturer instructions and applicable building codes.

For additional information, go to lpcorp.com/resources/product-literature

For realistic texture previews, place the "LP Building Solutions Product Textures" folder in your C:\ directory and then reopen this file.

©2019 Louisiana-Pacific Corporation. All rights reserved.

Scale 1" = 1'-0"



LP® SmartSide®
Lap Siding
Details - Exterior Insulation Applications

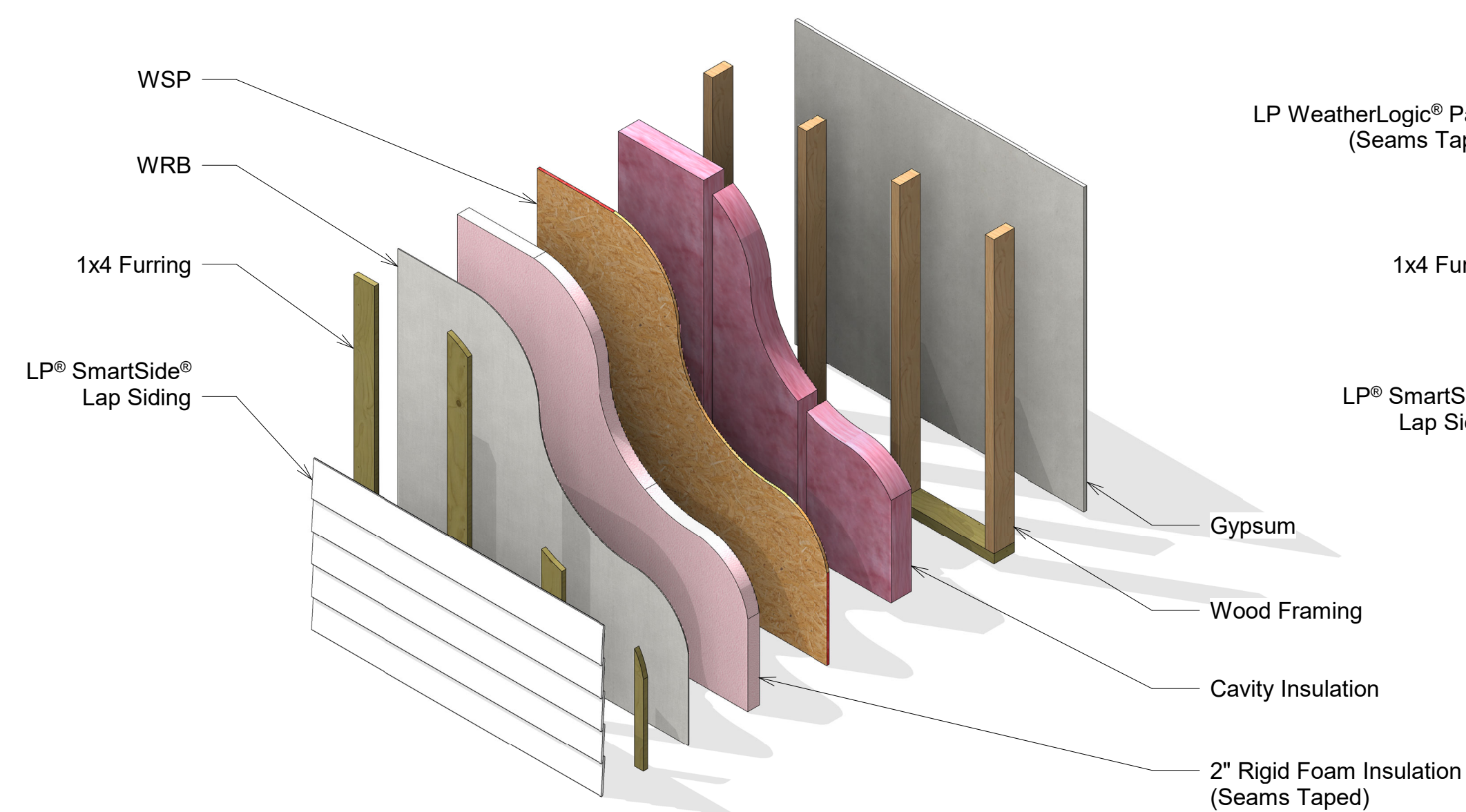

1 Exploded Isometric 4 - Exterior Insulation Application 1

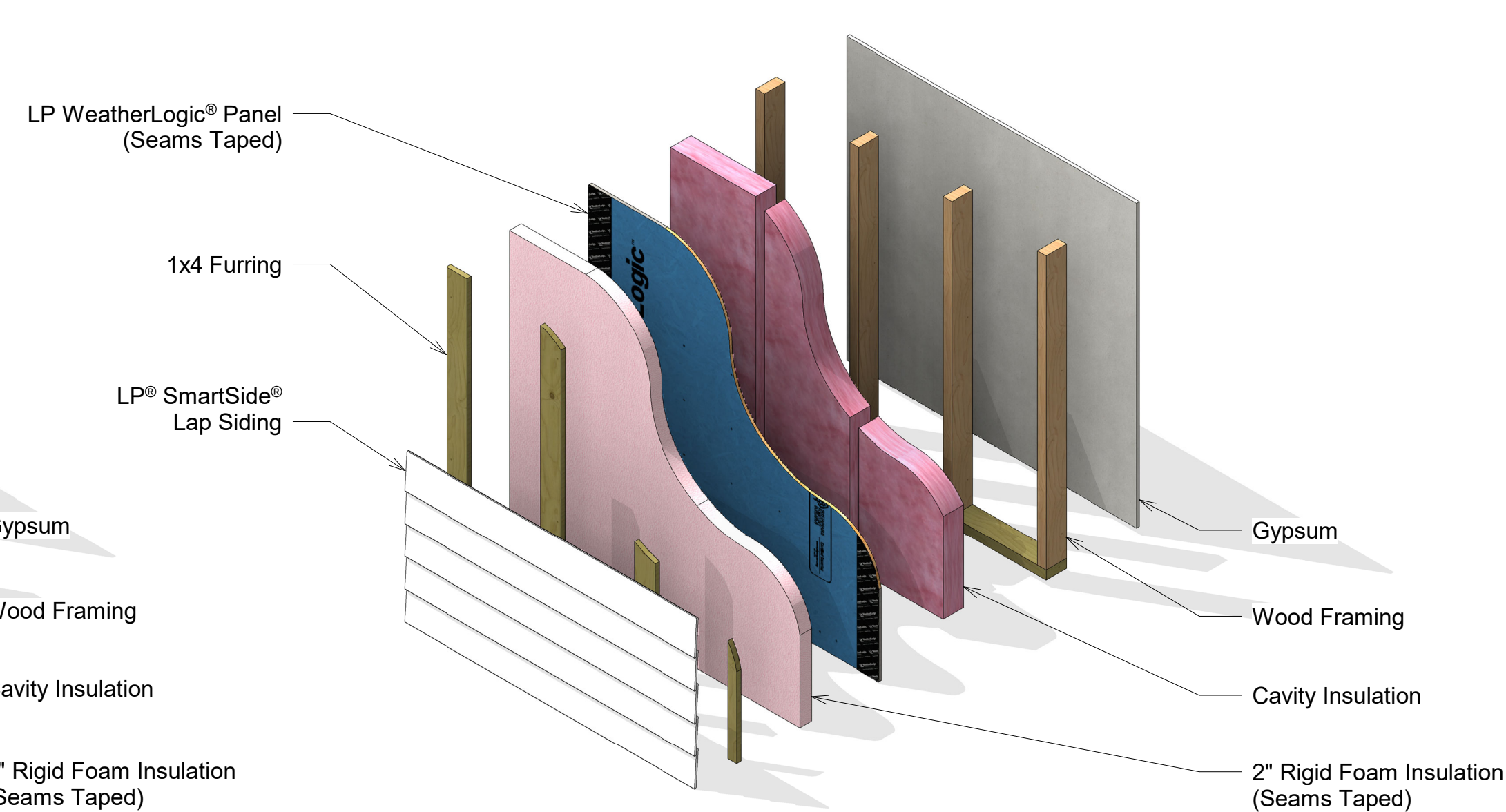

2 Exploded Isometric 5 - Exterior Insulation Application 2

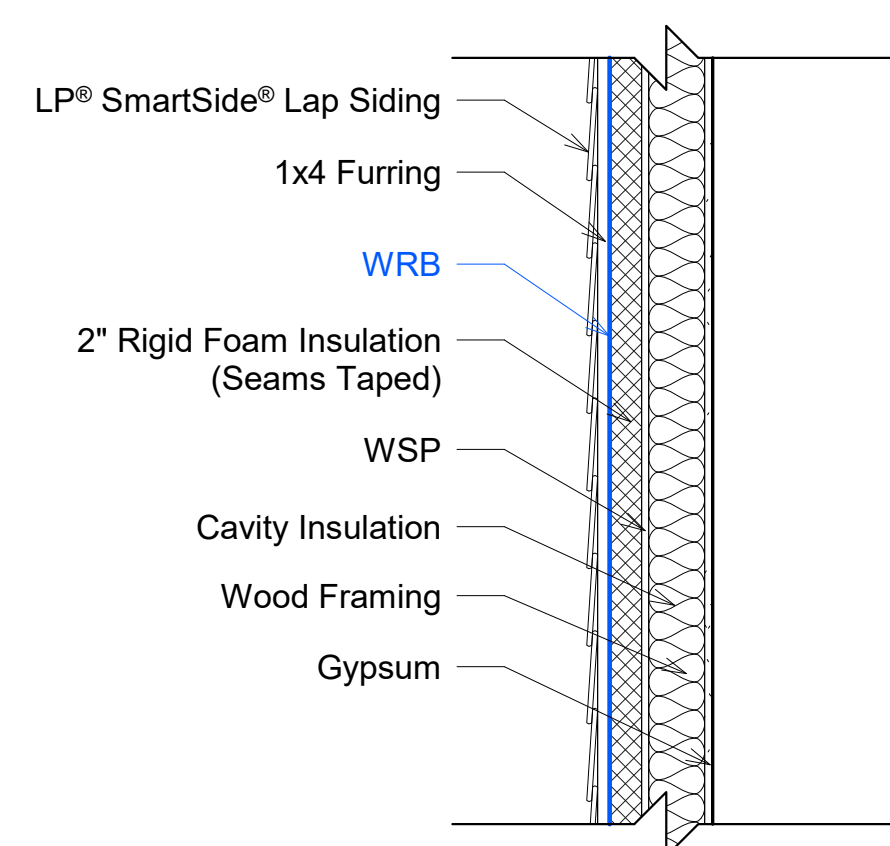

3 Section 4 - Exterior Insulation Application 1
1" = 1'-0"

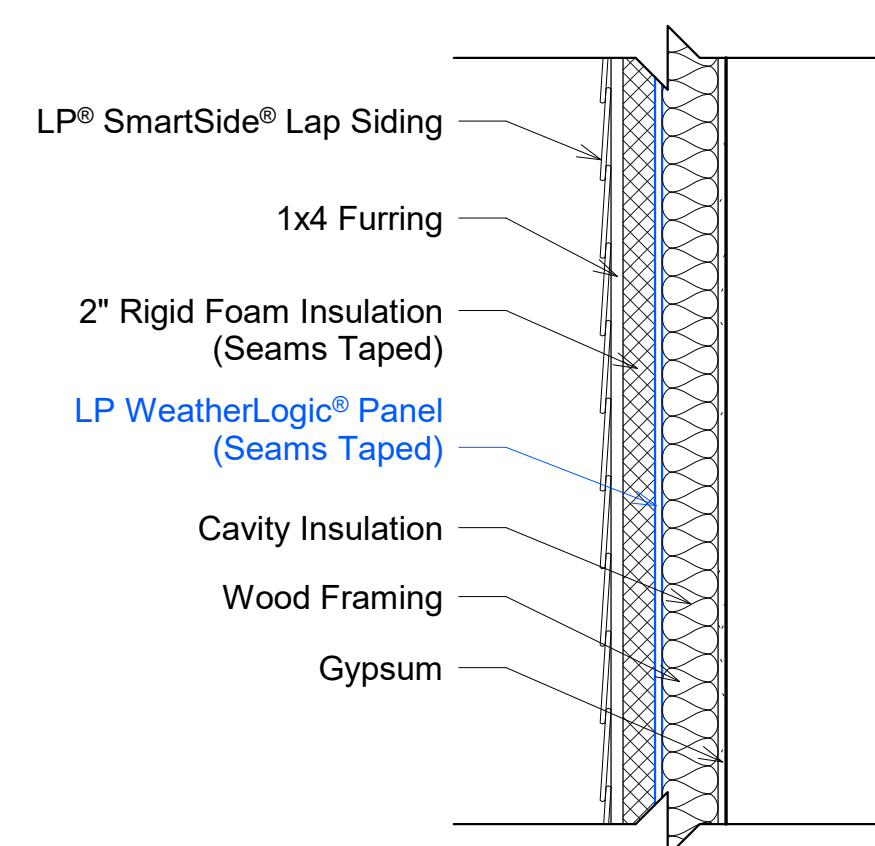

4 Section 5 - Exterior Insulation Application 2
1" = 1'-0"

Note: Use the manufacturer-recommended tape for the selected rigid foam insulation. Use LP WeatherLogic® Seam & Flashing Tape for the LP WeatherLogic® Panel. Follow all manufacturer instructions when installing tape products.

LPCorp.com
800-450-6106

Notes:
These drawings are general illustrations and are not to be used as final construction details. Check your local building codes before installing siding to confirm whether wood structural panel wall sheathing is required. Follow all manufacturer instructions and applicable building codes.

For additional information, go to lpcorp.com/resources/product-literature

For realistic texture previews, place the "LP Building Solutions Product Textures" folder in your C:\ directory and then reopen this file.

©2019 Louisiana-Pacific Corporation. All rights reserved.

Scale 1" = 1'-0"