

S7 SPRINKLER SUPPORT

Assembly Capacity 270 lbs.

4x6 cross member
requires three 16d
(3-1/2") nails per end

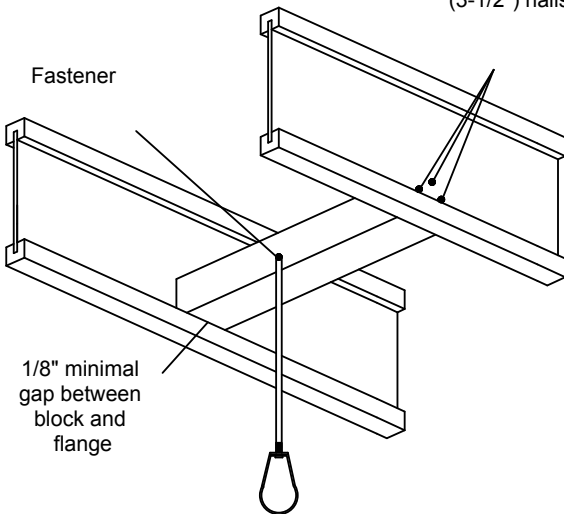

Verify hanger capacity with manufacturer.