

H5

BEVELED PLATE w/ 2x OVERHANG

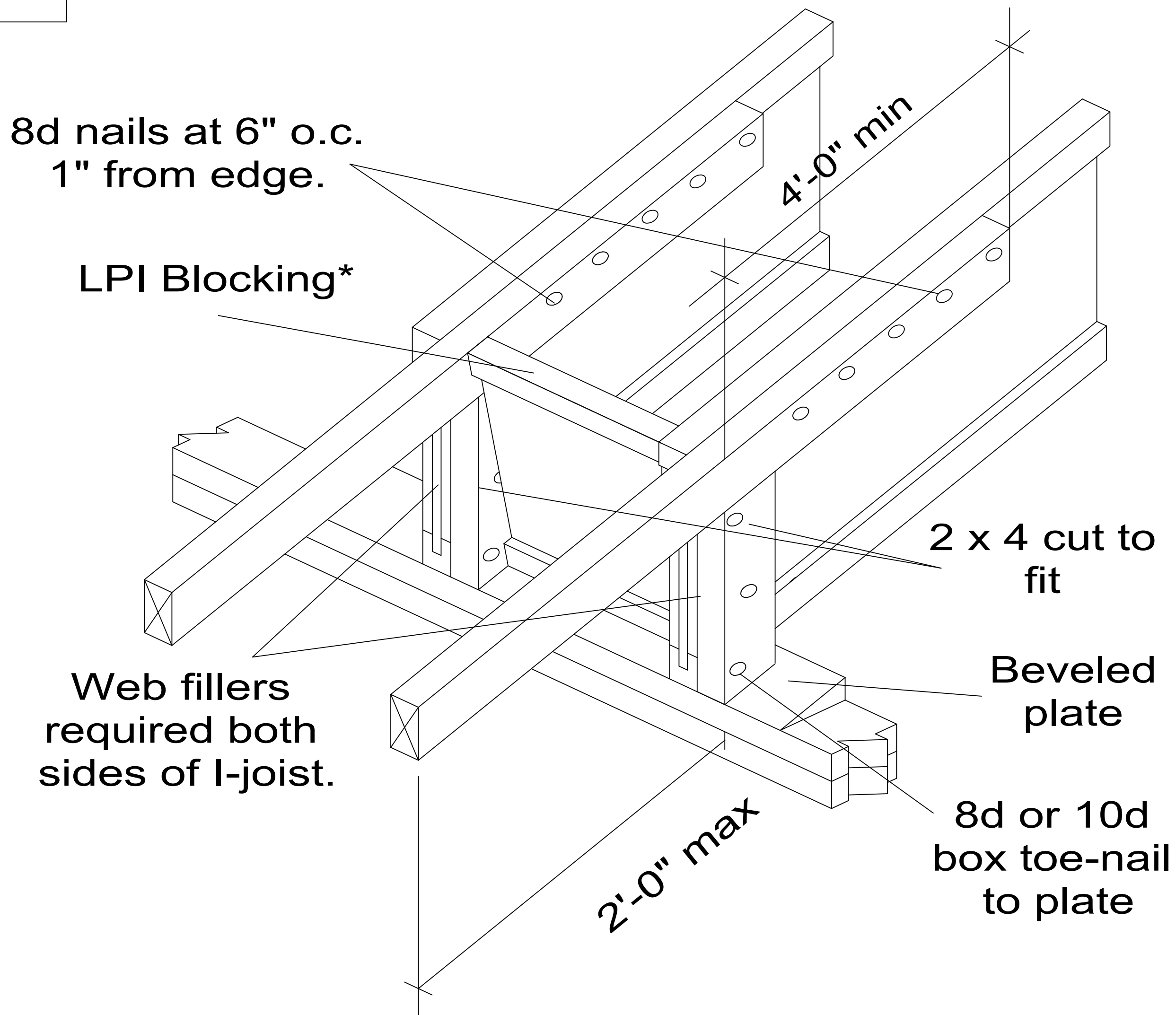

* Lateral resistance shall be provided. Other methods of restraint, such as full depth LP® SolidStart® OSB Rim, LSL, or LVL may be substituted for the LPI blocking shown.