



## PRIMED CEDARGROOVE 4" OC

## GENERAL

- At the time of manufacture, siding meets or exceeds the performance standards set forth in Composite Panel Association ANSI 135.6-2006 and has achieved code recognition under Legacy National Evaluation Report NER-626 and CCMC-12353L. For copies of these reports, call LP Customer Support at 1-800-577-4836.
- Minimum 6 in. clearance must be maintained between siding and finish grade.
- Siding applied adjacent to porches, patios, walks, etc. must have a clearance of at least 1 in. above any surface.
- Minimum 1" clearance at intersection with roof line
- All exposed wood substrate must be sealed in a manner that prevents moisture intrusion and water buildup.
- All exposed wood substrate must be primed and painted in a manner that prevents moisture intrusion and water buildup.
- When using wet blown cellulose insulation, adequate drying time must be allowed prior to enclosing the wall cavity
- In non-traditional ICF and SIP assemblies, the ICF or SIP manufacturer must prescribe the fastening specifications. Note: LP does not recommend LP Primed Cedar Groove for use in these non-traditional assemblies.
- DO NOT USE STAPLES

## STORAGE

- Store off the ground well supported, on a flat surface, under a roof or separate waterproof covering
- Keep siding clean and dry. Inspect prior to application.
- Allow siding to adjust to atmospheric conditions before application.

## STUD SPACING

- CedarGroove 4" OC panel siding may be applied over sheathed walls or, where building codes permit, directly to studs spaced no greater than 16 in. O.C. that have adequate corner bracing.
- In all installations over masonry walls, the wall must be furred out and open at top and bottom to allow for convective ventilation with framing spaced 16 in. O.C. and with adequate thickness to accept 1-1/2 inch nail penetration.

## MOISTURE

- Moisture control and moisture vapor control are critical elements of proper housing design. Check your local building codes for application procedures for handling moisture and moisture vapor in your area.
- As with all wood products, do not apply engineered wood siding to a structure having excessive moisture conditions such as drying concrete or plaster. If such conditions exist, the building should be well ventilated to allow it to dry prior to the application of the siding.
- Siding must not be applied to green or crooked structural framing members. Do not apply siding over rain-soaked or buckled sheathing materials.
- Gutters are recommended for control of roof water run off.

## SECONDARY WEATHER RESISTANT BARRIER

- A properly installed breathable water-resistive barrier is required behind the siding.
- Consult your local building code for details.
- LP will assume no responsibility for water penetration.

## GAPS &amp; SEALANTS

- Seal all gaps with a high-quality, non-hardening, paintable sealant with a minimum stated service life of 30 years. Follow the sealant manufacturer's instructions for application.

## FLASHING, WINDOWS, DOORS &amp; OPENINGS

- All openings must be properly sealed or flashed in a manner that prevents moisture intrusion or buildup. Several examples that accomplish this are shown on the following pages.

## KICK-OUT FLASHING

- Install kick-out flashing to direct the water into the gutter
- Install step flashing with minimum 4-inch upper leg
- Properly integrate flashing with the secondary water-resistive barrier. Use housewrap, flashing tape, z-flashing, or other items as needed to maintain the counterflashing principle.
- DO NOT extend the siding or trim into the kick-out flashing or gutter
- Maintain a clearance between the end of the gutter and the adjoining wall to allow for proper maintenance of the siding
- Paint ALL exposed cut edges

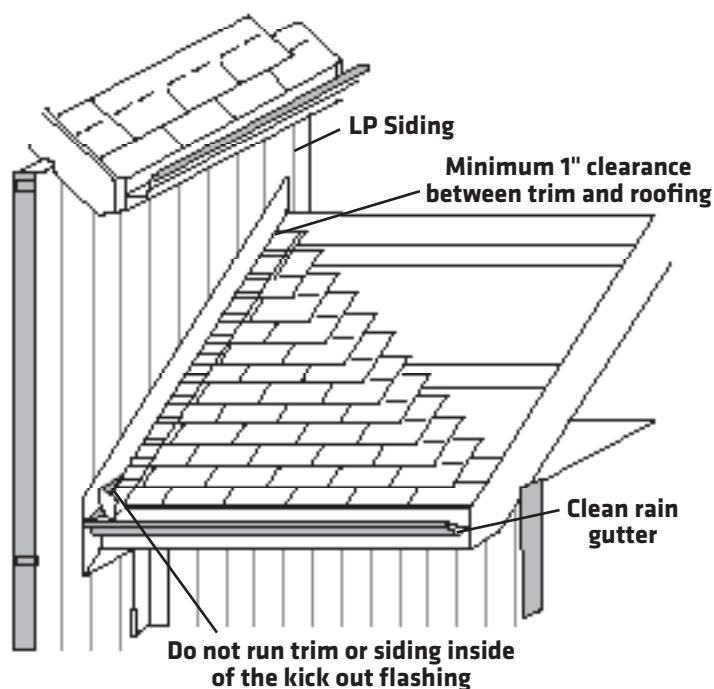

## APPLICATION INSTRUCTIONS (CONT.)

### TRIM

Trim should be thick enough so the siding does not extend beyond the face of the trim.

- Trim and fascia must be applied in a manner that will not allow moisture intrusion or water buildup.
- CedarGroove 4" OC siding is not designed and/or manufactured to be used as trim or fascia. LP SmartSide trim and fascia are available in a variety of dimensions.

### FINISHING INSTRUCTIONS

#### DO

- **Prime and paint all exposed surfaces including all drip edges or where water will hang.**
- Apply finish coat as soon as possible or within 180 days of application.
- High-quality acrylic latex paint, specially formulated for use on wood and engineered wood substrates, is highly recommended. Semi-gloss or satin finish oil or alkyd paints are acceptable. For flat alkyd paint, please check with the coating manufacturer for their recommendations for use on composite wood siding.
- Follow the coating manufacturer's application and maintenance instructions.

#### DO NOT USE











- Semi-transparent and transparent stains.
- Shake and shingle paints.
- Vinyl-based resin formulas such as vinyl acetate, PVA, vinyl acetate/acrylic copolymer paints.

#### NOT RECOMMENDED:

- Semi-transparent stain.
- Shake and shingle paints.
- Vinyl-based resin formulas such as vinyl acetate, PVA, vinyl acetate/acrylic copolymer paints.

### SIDING APPLICATOR INSTRUCTIONS: CedarGroove 4" OC Panel

- Apply siding over framing with a maximum stud spacing of 16 in. O.C.
- All siding must be installed over framing members no less than 2 in. x 4 in..
- Shiplap edges must fall on studs. Position underlap shiplap flange at center of stud. Refer to Figure 2e on page 4.
- Horizontal joints must be supported by framing. Leave a 3/8 in. gap and flash joints with a noncorrosive "Z" flashing.
- When panels butt against window and door trim and at inside and outside corners, leave a 3/16 in. gap and caulk.
- LP siding may be sawn face up with a fine-tooth handsaw or face down with a combination blade power saw.
- NAILS MUST PENETRATE FRAMING MEMBERS AT LEAST 1-1/2 in.** For best performance use hot-dipped galvanized nails with a minimum 1/4 in. diameter head. **DO NOT OVERDRIVE NAILS.** Nail head should seat firmly to face of siding but not be overdriven to distort the siding surface.

CONDITION		CORRECTION	
Snug		OK	
Flush		OK	
Visible fiber		Paint	
Countersunk 1/16 in.-1/8 in.		Seal with caulking	
Countersunk more than 1/8 in.		Seal with caulk and re nail	

- When installing siding over a maximum 1" foam sheathing, care must be taken not to drive nails so hard as to compress the foam and distort the siding surface.
- DOUBLE NAILING AT VERTICAL JOINTS IS REQUIRED. (See drawing)
- Space nails 6 in. O.C. on all siding edges and 12 in. O.C. at intermediate framing members. Nails spaced 6 in. O.C. on underlap flange will be covered by overlap flange. Nails spaced 6 in. O.C. on overlap flange should be 1" in from edge of panel.
- For Additional Racking Strength, to meet FHA Technical Circular 12 as sheathing siding, where local codes permit, nails must be spaced 4 in. O.C. on all panel edge and 8 in. O.C. at intermediate framing studs. Nail penetration must be a minimum of 1-1/2 in. into all framing members.

The Louisiana-Pacific Corporation ("LP") LP CedarGroove 4" OC panel (the "Product") limited warranty (the "Warranty") applies only to structures on which the Product has been applied, finished and maintained in accordance with the published application, finishing and maintenance instructions in effect at the time of application. The failure to follow such application, finishing or maintenance instructions will void the Warranty as to the portion of the Product affected by the variance (the "Affected Product").

LP assumes no liability for any loss or damage sustained by the Affected Products and is expressly released by the purchaser or owner from any such loss or liability.

Any modification of the Warranty's application, finishing or maintenance requirements is void and unenforceable unless approved in writing prior to application by the Siding General Manager or his designee and a member of the LP Legal Department.

For a copy of the warranty or for installation and technical support, visit the LP CedarGroove Siding product support Web site at:

[www.lpcorp.com](http://www.lpcorp.com)

or for additional support call 800.450.6106.

WARRANTY REMEDIES ARE NOT AVAILABLE IF REQUIREMENTS ARE NOT FOLLOWED.



© 2014 Louisiana-Pacific Corporation. All rights reserved. LP and SmartSide are registered trademarks of Louisiana-Pacific Corporation. Printed in U.S.A.

NOTE: Louisiana-Pacific Corporation periodically updates and revises its product information. To verify that this version is current, call 800-450-6106.

LPZB0564

## over openings

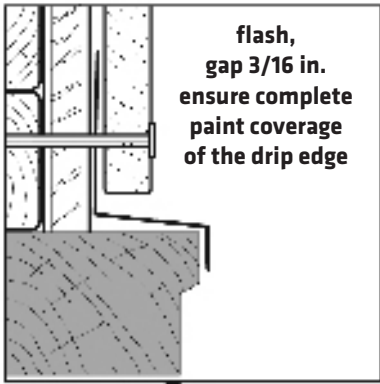

## alternate panel stacking details

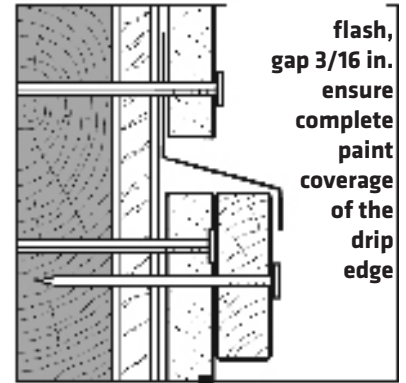
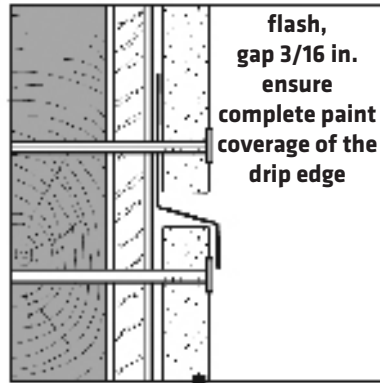

Shiplap  
Panel Siding

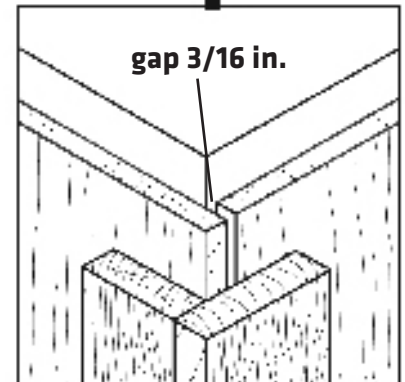
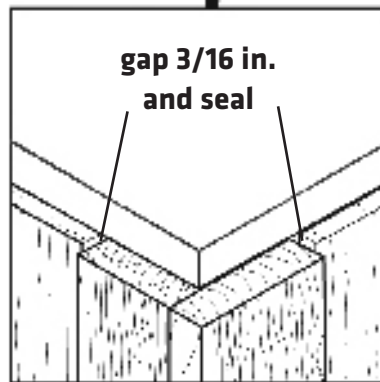
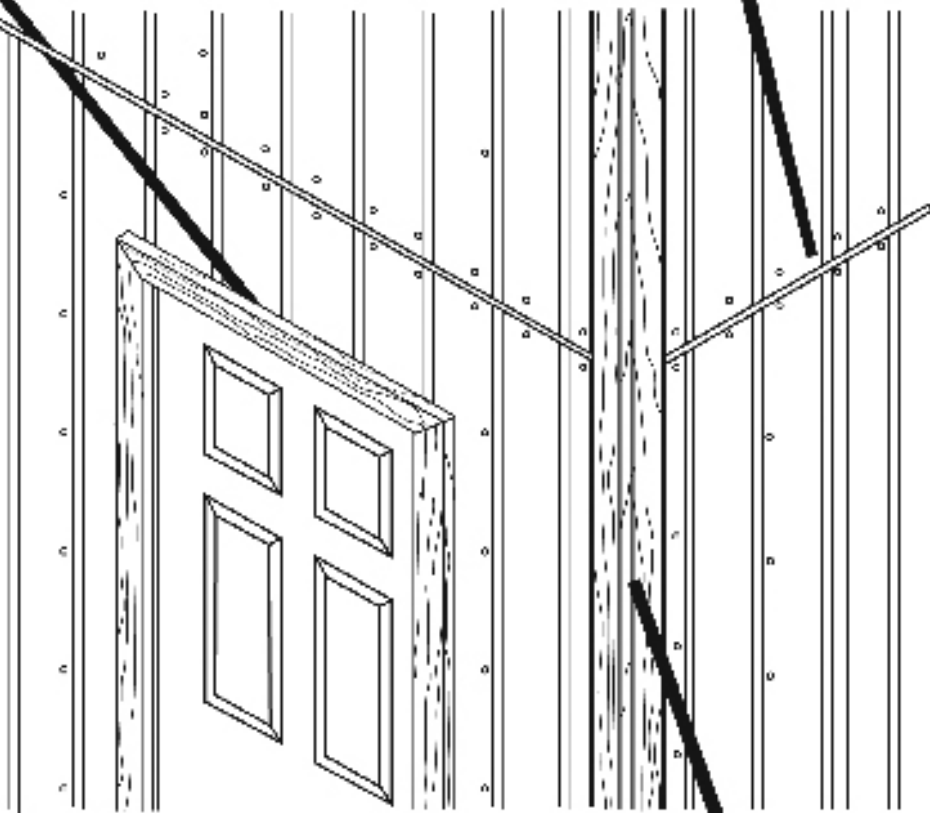

## outside corner details

# roof flashing detail

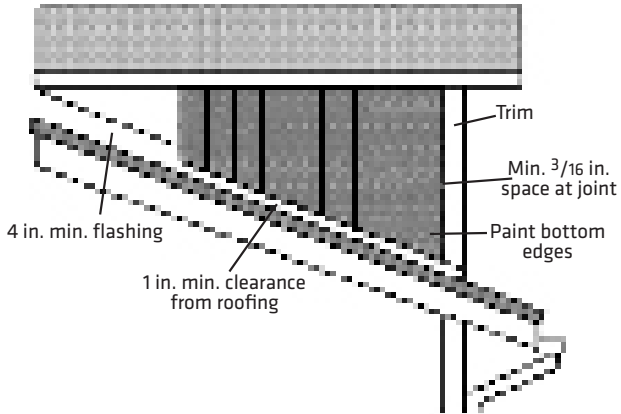

# alternate inside corner details

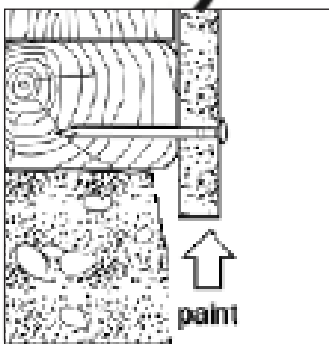
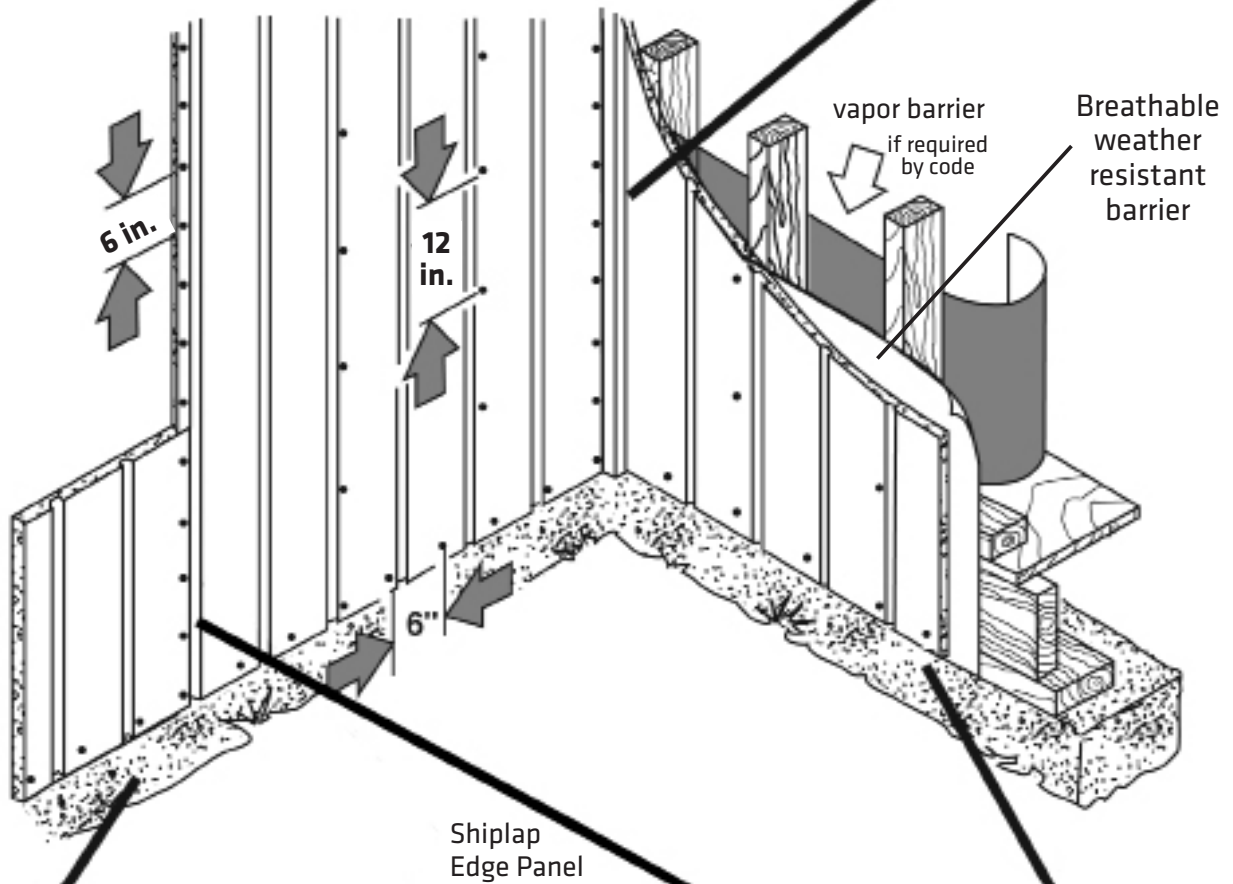
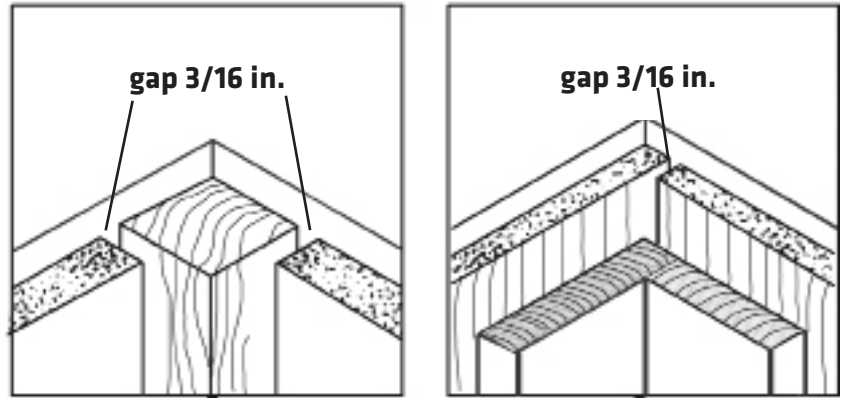

### bottom course detail

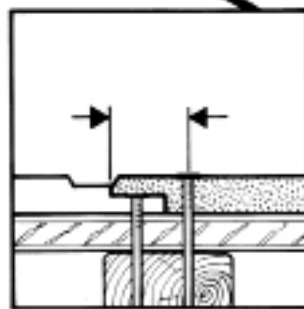

### panel joint



### ground clearance