



SMARTSIDE®
TRIM & SIDING

**TRIM AND FASCIA
540 SERIES AND 440 SERIES**

GENERAL

- There are no National Standards for wood composite substrate trim.
- LP SmartSide trim and fascia can be applied directly over materials such as siding, or nailed directly to structural members up to 609.6 mm O.C.
- Always check your local building code to confirm that the trim and fascia may be applied directly to structural members.
- Do not use North of the Tropic of Capricorn
- Do not let trim contact masonry.
- Minimum 152.4 mm clearance must be maintained between trim and finish grade.
- Trim applied adjacent to porches, patios, walks, etc. must have a clearance of at least 25.4 mm above any surface where water might collect. The surface must be sloped or otherwise designed to provide proper drainage so the trim is at no time directly exposed to standing water.
- LP SmartSide trim and fascia are not designed for (a) siding; or (b) structural applications and should not be used as a structural member in construction such as a trellis, railing, fencing.
- A non-corrosive drip-edge or drip-cap must be applied at bottom edge of roofing where it meets the fascia.
- Trim and fascia must not be applied to green or crooked structural framing members. Do not apply trim and/or fascia over rain soaked or buckled sheathing materials.
- **DO NOT USE STAPLES**

STORAGE

- Store off the ground on a flat surface, under a roof or separate waterproof covering.
- Keep trim and fascia clean and dry. Inspect prior to application.
- Allow trim and fascia to adjust to atmospheric conditions before application.

MOISTURE

- Moisture control and moisture vapor control are critical elements of proper housing design. Check your local building codes for application procedures for handling moisture and moisture vapor in your area.
- Follow all applicable building code specifications relating to prevention of moisture intrusion into the wall assembly. LP SmartSide trim and fascia is a wood product, and, as with all wood products, must be kept free from constant sources of moisture. Lack of proper ventilation; exposure to repetitive sources of water such as sprinklers, condensation, inadequate flashing; improper sealing; or failure to follow common building practices that prevent moisture intrusion into the wall-system; may cause damage, and will void the warranty.





CUTTING

- For the cleanest cut and longer blade life, a fine-tooth carbide tipped blade is recommended.
- LP® SmartSide® trim and fascia are manufactured with a special edge coating which reduces moisture-related issues. Avoid ripping and routing of trim and fascia, as it will leave the edges unprotected. If the trim or fascia materials must be ripped you must, take special care to prime, paint and seal all exposed wood fiber as described in the finishing section.





NAILING

- Use a minimum 2.9mm x 52mm galvanized or stainless steel clout, with a minimum 6.4 mm diameter head.
- Penetrate studs or studs and wood sheathing a combined 25.4 mm.
- Leave 4.8 mm gap where trim butts into other materials and at butt joints, miter joints and ends. Where edges of trim meet siding material, windows, doors or other finished openings, leave a minimum 3.2 mm gap to allow for proper sealing. Provide increased spacing along the trim if specified by the siding installation instructions.
- Leave 25.4 mm clearance between trim and roofing materials at roof rake.
- For edge-nailing, all nail holes must be pre-drilled. Do not attempt to edge-nail without pre-drilling.
- When applied as rake, corner or band board, nails must be spaced no further than 304.8 mm apart on alternating edges. Nails must be at least 9.5 mm from the edge.

CONDITION

- Snug 
- Flush 
- Visible fiber 
- Countersunk 1.6 - 3.2 mm 
- Countersunk more than 3.2 mm 

CORRECTION

- OK 
- OK 
- Paint 
- Apply sealant 
- Apply exterior putty and re-nail 

Application instructions (cont.)

FLASHING, WINDOWS, DOORS & OPENINGS

- All openings must be sealed and flashed in a manner that prevents moisture intrusion or water buildup. Several examples that accomplish this are shown.
- In a horizontal brick frieze or band board application where the trim overlaps the masonry leave a 4.8 mm minimum airspace or a layer of flashing between the trim and the masonry.
- Horizontal trim or bands should be flashed with a drip cap to redirect water away from the wall assembly.

INSIDE CORNER DETAIL

Trim must extend beyond face of siding.

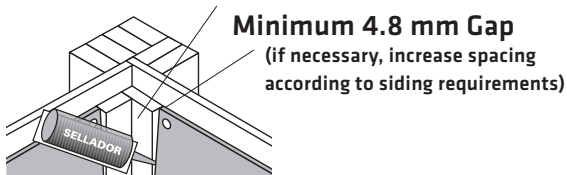

OUTSIDE CORNER DETAIL

Trim must extend beyond face of siding.

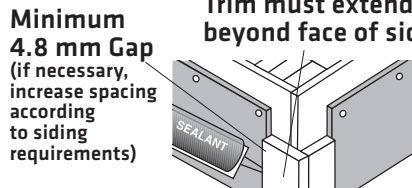

ALTERNATE OUTSIDE CORNER DETAIL

Minimum 50.8 mm space siding 4.8 mm overlap from corner of wall

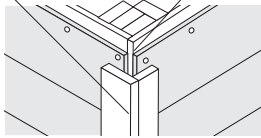

BUTT JOINT DETAIL

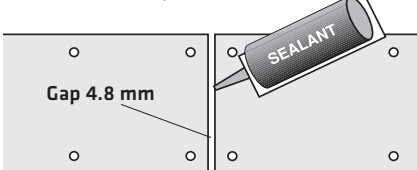

DOORS & WINDOWS

Minimum 4.8 mm Gap (if necessary, increase spacing according to siding requirements)



HORIZONTAL TRIM AND BAND BOARD

Weather Resistant Barrier

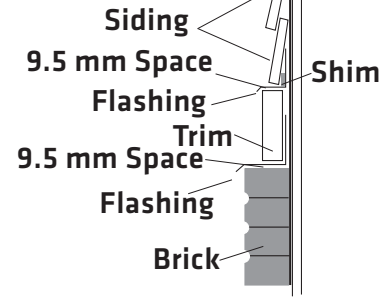

KICK-OUT FLASHING

- Install kick-out flashing to direct the water into the gutter
- Install step flashing with minimum 4-inch upper leg
- Properly integrate flashing with the secondary water-resistive barrier. Use housewrap, flashing tape, z-flashing, or other items as needed to maintain the counterflashing principle.
- DO NOT extend the siding or trim into the kick-out flashing or gutter
- Maintain a clearance between the end of the gutter and the adjoining wall to allow for proper maintenance of the siding
- Paint ALL exposed cut edges

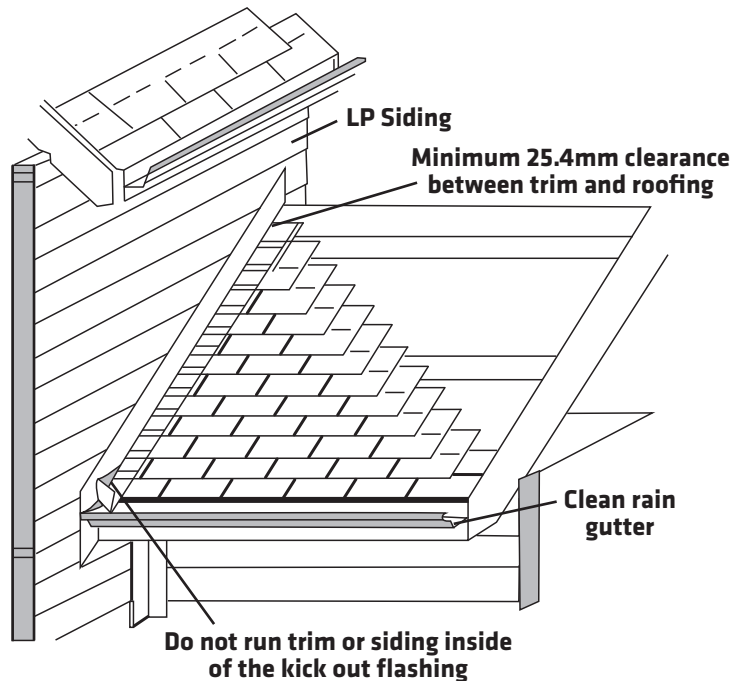

GAPS, SEALANT & JOINTS

- Seal all gaps with a high-quality, non-hardening, paintable sealant with a minimum stated service life of 30 years. Follow the sealant manufacturer's instructions for application.

JOINT DETAIL

Ends must be spaced and joints may lightly touch in runs less than 4876.8 mm. Butt joints require an 4.8 mm gap in runs over 4876.8 mm. Seal with a high quality non-hardening paintable long-life sealant. Butt joints require four (4) nails with two nails on either side of the joint at each edge.

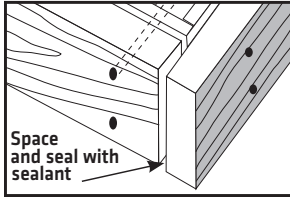
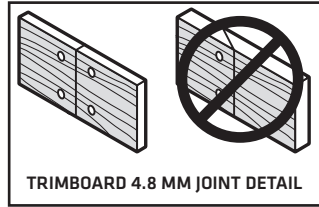

End-to-end joints in vertical trim should be installed so that they shed water.

Do not miter corner joints of band boards, fascia, etc. Allow the end of the trim to lap over the end of the adjoining trim and space 4.8 mm.

GABLE ENDS

- At gable ends, a backer board (such as a barge rafter) should be used under fascia to provide maximum support along the length of the product (see Diagram A).
- If LP SmartSide trim and fascia is installed directly to lookouts on an overhanging rake, the lookouts must be installed edgewise and must be spaced no wider than 609.6 mm O.C. (see Diagram B). THIS APPLICATION APPLIES TO MINIMUM 152.4 mm 540 SERIES STRAND TRIM ONLY.

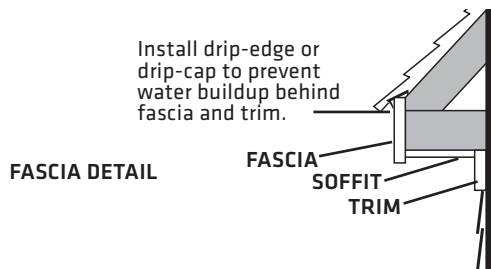
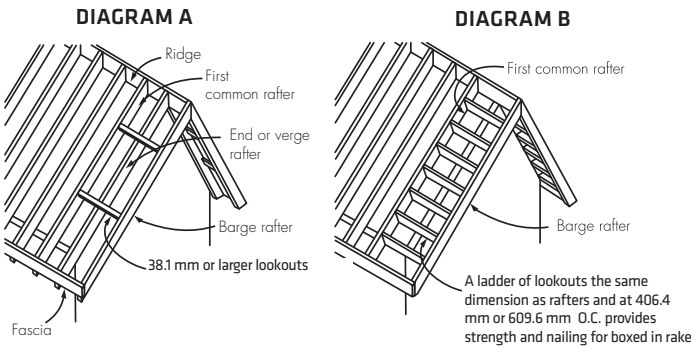

MITERING

- Do not miter trim edges. 45 degree mitering of trim ends around door and window openings is acceptable.

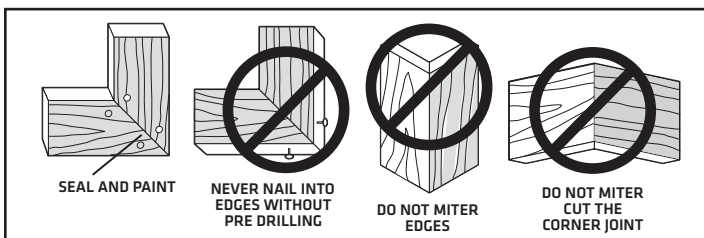

FASCIA AND RAKE BOARDS AT CORNERS

- All joints must be supported by framing. Do not nail from the face of one trim member into the edge of another. Do not miter cut the corner joint.

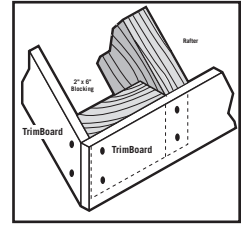

FINISHING

DO

- Prime and paint all exposed surfaces.
- Apply finish coat as soon as possible or within 180 days of application.
- High-quality acrylic latex paint, specially formulated for use on wood and engineered wood substrates, is highly recommended. Semi-gloss or satin finish oil or alkyd paints are acceptable. For flat alkyd paint, please check with the coating manufacturer for their recommendations for use on composite wood siding.
- Follow the coating manufacturer's application and maintenance instructions.

DO NOT USE

- Semi-transparent and transparent stains.
- Shake and shingle paints.
- Vinyl-based resin formulas such as vinyl acetate, PVA, vinyl acetate/acrylic copolymer paints.

The Louisiana-Pacific Corporation ("LP") LP SmartSide trim and fascia (the "Products") limited warranty (the "Warranty") applies only to structures on which the Products have been applied, finished and maintained in accordance with the published application, finishing and maintenance instructions in effect at the time of application. In Australia, our goods come with guarantees that cannot be excluded under the Australian Consumer Law. You are entitled to a replacement or refund for a major failure and for compensation for any other loss or damage. You are also entitled to have the goods repaired or replaced if the goods fail to be of acceptable quality and the failure does not amount to a major failure.

Any modification of the Warranty's application, finishing or maintenance requirements is void and unenforceable unless approved in writing prior to application by the Siding General Manager or his designee and a member of the LP Legal Department.

For a copy of the warranty or for installation and technical support, visit the LP SmartSide product support Web site at:

www.lpcorp.com
or for additional support call 800.450.6106.



©2014 Louisiana-Pacific Corporation. All rights reserved. Printed in USA. LP and SmartSide are registered trademarks of Louisiana-Pacific.

NOTE: Louisiana-Pacific Corporation periodically updates and revises its product information. To verify that this version is current, call 800-450-6106.